

Guidelines

For Solar Photovoltaic Installation
Under The Programme Of
NEM Rakyat And NEM GoME
In Peninsular Malaysia

Electricity Supply Act 1990 [Act447]

**GUIDELINES FOR SOLAR PHOTOVOLTAIC
INSTALLATION UNDER THE PROGRAMME OF
NEM RAKYAT AND NEM GoME_n IN
PENINSULAR MALAYSIA**

FEBRUARY 2021

DOCUMENT CONTROL				
VERSION	REGISTRATION NUMBER	REGISTRATION DATE	EFFECTIVE DATE	ISSUANCE/ AMENDMENTS
1	GP/ST/No. 27/2021	30.01.2021	30.01.2021	

In exercise of the power conferred by Section 50C of the Electricity Supply Act 1990 [Act 447], the Commission issues the following guidelines.

Citation and Commencement

1. These guidelines may be cited as the Guidelines For Solar Photovoltaic Installation Under The Programme Of NEM Rakyat and NEM GoMEIn In Peninsular Malaysia (“Guidelines”).
2. These Guidelines shall come into operation on the date of its registration.

Purpose of these Guidelines

3. The purpose of these Guidelines is to promote renewable Energy through Installation of solar systems on residential and government premises primarily for self-consumption and any excess Energy to be exported under the NEM Rakyat and NEM GoMEIn programmes.

Amendment and Variation

4. The Commission may at any time modify, vary, review or revoke these Guidelines.

Dated: 30 January 2021



Abdul Razib bin Dawood
Chief Executive Officer
Energy Commission

TABLE OF CONTENTS

1.	OBJECTIVES	4
2.	APPLICATION OF THESE GUIDELINES.....	4
3.	DEFINITIONS AND INTERPRETATION	4
4.	ELIGIBILITY CAPACITY AND PERIOD OF APPLICATION	9
5.	ELIGIBILITY CRITERIA.....	10
6.	TYPES OF INSTALLATION ALLOWED	10
7.	CAPACITY LIMIT	10
8.	CONNECTION OF SOLAR PV INSTALLATION.....	11
9.	NET ENERGY METERING ASSESSMENT STUDY (NEMAS).....	11
10.	TECHNICAL REQUIREMENTS	13
11.	METER INSTALLATION, TESTING AND COMMISSIONING	14
12.	MATTERS RELATING TO PRICING AND TARIFF	15
13.	ENERGY ACCOUNTING AND SETTLEMENT.....	16
14.	PROCEDURE FOR APPLICATION.....	17
15.	NEM CONTRACT	18
16.	CHANGE OF OWNERSHIP	18
17.	LICENSING REQUIREMENT	18
18.	ENVIRONMENTAL ATTRIBUTE	19
19.	NOTICE BY THE COMMISSION.....	19

1. OBJECTIVES

- 1.1 These Guidelines are developed by the Commission for the following objectives:
- (a) to prescribe the principles of two (2) initiatives under the NEM 3.0 Programme, namely NEM Rakyat and NEM GoMEn;
 - (b) to set out roles and responsibilities of the Implementing Agency, Distribution Licensee and NEM Consumer in NEM Rakyat and NEM GoMEn; and
 - (c) to regulate matters relating to the implementation and operation of the NEM Rakyat and NEM GoMEn.

2. APPLICATION OF THESE GUIDELINES

- 2.1. These Guidelines shall apply to:
- (a) any Domestic Consumer and Government Agency complying with these Guidelines in participating in the NEM Rakyat and NEM GoMEn in Peninsular Malaysia;
 - (b) the relevant Distribution Licensee, whose Distribution System is connected to the NEM Consumer; and
 - (c) the Implementing Agency for the NEM Rakyat and NEM GoMEn.
- 2.2. These Guidelines are not intended in any way to circumvent the application of and obligations or requirements under any other written law or standards. Parties relying on these Guidelines are advised to obtain independent advice on the applicability of the same to their Installations.

3. DEFINITIONS AND INTERPRETATION

- 3.1. In these Guidelines, the following terms shall bear the following meanings:

“Act”	means the Electricity Supply Act 1990 [Act 447], as amended, modified or supplemented from time to time;
“Applicant”	means a person applying to be a NEM Consumer of a Distribution Licensee;

“Billing Period”	means the period for which electricity bills shall be prepared for the NEM Consumers by the Distribution Licensee;
“Commencement Date”	means the start of the operation of solar PV Installations for NEM 3.0 Programme;
“Commission”	means Suruhanjaya Tenaga;
“Consumer”	means an owner or occupier of a premise who is supplied or required to be supplied with electricity by the Distribution Licensee;
“Distribution Licensee”	means TNB, who is the holder of a licence to distribute electricity issued by the Commission under Section 9 of the Act, for the purpose of these Guidelines;
“Distribution System”	means an electricity system of electric lines, cables, switchgear and associated equipment at nominal voltage of less than 66kV that is used, worked or operated by the Distribution Licensee;
“Domestic Consumer”	means a consumer occupying a private dwelling premise which is not used as a hotel, boarding house or used for the purpose of carrying out any form of business, trade, professional activities or services;
“Electricity Supply Agreement”	means the agreement entered into between TNB and NEM Consumer;
“Energy”	means electrical Energy, measured in the units of kWh or MWh;
“Energy Laws”	means the Act and all subsidiary legislations made thereunder, as amended, modified or supplemented from time to time;
“Government Agency”	means a ministry, department or statutory body established by the government at all levels of administration whether at the federal,

	state or district levels, including local authorities and the electricity account for purpose of NEM GoMEn eligibility will be classified under commercial tariff category;
“ICPT”	means Imbalanced Cost Pass Through;
“Implementing Agency”	means Sustainable Energy Development Authority (SEDA), as the implementing agency which is responsible to implement and administer the NEM Rakyat and NEM GoMEn;
“Indirect Connection”	means the connection of a solar PV Installation to a supply line indirectly through the internal distribution board of the NEM Consumer where the solar PV Installation is connected to an electrical point within the Premise of the NEM Consumer instead of the Point of Interconnection;
“Installation”	has the same meaning as in Section 2 of the Act;
“kV”	means kilovolt or 1,000 volt;
“kW”	means kilowatt in ac rating;
“kWp”	means kilowatt peak. Rated kWp in relation to a PV Installation means the maximum direct current power such Installation can produce under standard test conditions of 1000 watts per square meter of solar irradiation and 25 degrees Celsius ambient temperature;
“KWTBB”	means Kumpulan Wang Tenaga Boleh Baharu;
“Low Voltage”	means a voltage normally not exceeding 1,000 volts alternating current or 1,500 volts direct current between conductors, or 600 volts alternating current or 900 volts direct current between conductor and earth;

“Maximum Demand”	means twice the largest number of kilowatt-hours used during any consecutive thirty (30) minutes in a month;
“Medium Voltage”	means a voltage normally exceeding Low Voltage but equal to or not exceeding 50,000 volts;
“MW”	means megawatt or 1,000 kilowatts in ac rating;
“NEM”	means Net Energy Metering;
“NEM 3.0 Programme”	means the mechanism where a NEM Consumer installed a solar PV Installation on the roof-top of his Premise primarily for his own use. During the first ten (10) years of operation, any excess Energy which is not consumed due to operational constraints or monthly or seasonal variation in load demands at the said Premise may be exported to the Distribution System. The credit to be received for such excess Energy may be used to offset part of the electricity bill for Energy provided by the Distribution Licensee during the applicable Billing Period, all in compliance with these Guidelines;
“NEM Consumer”	means a consumer with solar PV Installation under the NEM Rakyat or NEM GoMEn programme;
“NEM Contract”	means the agreement entered into between a NEM Consumer and a Distribution Licensee under the NEM 3.0 Programme;
“NEM GoMEn”	means one of the initiatives under the NEM 3.0 Programme for government ministries and entities, which had not participated in any of the prior solar programmes;

“NEMAS”	means Net Energy Metering Assessment Study, which is a technical analysis carried out by the Distribution Licensee or qualified consultants to assess the potential impact of the solar PV Installation on the planning and operation of the Distribution Licensee’s Distribution System;
“NEM Rakyat”	means one of the initiatives under the NEM 3.0 Programme for Domestic Consumer(s) who have not participated in any of the prior solar programmes;
“Point of Interconnection”	<p>means the point where the electrical Installation of the NEM Consumer is physically connected to the Distribution System operated by the Distribution Licensee, where:</p> <p>(a) for supplies at nominal voltage of 230 or 400 volts, the point is at the cut-off fuse; and</p> <p>(b) for supplies at nominal voltage of 11,000 or 33,000 volts, the point is at the incoming switchgear</p> <p>at the Premise of the NEM Consumer;</p>
“Premise”	means a building together with its land, outbuildings and any structures within the same compound occupied or used by the NEM Consumer;
“PV”	means photovoltaic;
“Settlement Period”	means the period starting from 1st January of a year and ending on 31st December of the same year, except for the first year on the Commencement Date of the NEM 3.0 Programme. The first year may not be a full twelve (12) months settlement period. For example, if the Commencement Date for a

NEM Consumer falls on July 2021, then the end of the settlement period will be on December 2021 which is only a six (6) months' period;

“SST” means Sale and Service Tax; and

“TNB” means Tenaga Nasional Berhad (Company No: 200866-W), a limited liability company with the address at No. 126, Jalan Bangsar, 59200 Kuala Lumpur, Malaysia.

3.2. Subject to paragraph 3.1, the words and expressions in the singular include the plural, and words and expressions in the plural include the singular and unless expressly indicated to the contrary or unless the context otherwise requires, terms adopted and used in these Guidelines shall bear the same meaning as they are defined in the Energy Laws.

3.3. If there are any conflict between the provisions of these Guidelines and of those contained in the Energy Laws, the provisions in the Energy Laws shall prevail.

4. ELIGIBILITY CAPACITY AND PERIOD OF APPLICATION

4.1. The total capacities eligible for application under the NEM 3.0 Programme in Peninsular Malaysia are as follows:

- (a) For Domestic Consumer – up to 100,000 kW; and
- (b) For Government Agency – up to 100,000 kW.

4.2. The NEM Rakyat and the NEM GoME are open for application from 1 February 2021 to 31 December 2023 and are available on a first-come-first-served basis.

5. ELIGIBILITY CRITERIA

- 5.1 The Applicant shall be a Consumer or a person applying to be a Consumer of the Distribution Licensee.
- 5.2 Any Consumer who has installed solar PV Installation under the previous solar PV programme is not eligible to participate in this programme.

6. TYPES OF INSTALLATION ALLOWED

- 6.1 The solar PV Installation shall be of PV panels mounted on the rooftop of the building within the same Premise.

7. CAPACITY LIMIT

- 7.1 For Domestic Consumers, the maximum capacity of the PV Installation shall be as follows:
 - (a) for single phase NEM Consumer, not more than 4 kW; and
 - (b) for three (3) phase NEM Consumer, not more than 10 kW.
- 7.2 For Government Agency, the maximum capacity of the PV Installation shall not exceed 1,000 kW and subject to the following conditions:
 - (a) for Medium Voltage Consumers, not exceeding 75% of Maximum Demand based on –
 - (i) the average of the recorded Maximum Demand of the past one (1) year; or
 - (ii) the declared Maximum Demand for Consumers with less than one (1) year record; and
 - (b) for Low Voltage Consumers, not exceeding 60% of fuse rating (for direct meter) or 60% of the current transformer (CT) rating of the metering current transformers.

8. CONNECTION OF SOLAR PV INSTALLATION

- 8.1 Connection to the Distribution System shall be through Indirect Connection. **Figure 1** shows the diagram of the connection between the NEM Consumer's solar PV Installation and the Distribution Licensee's Distribution System.

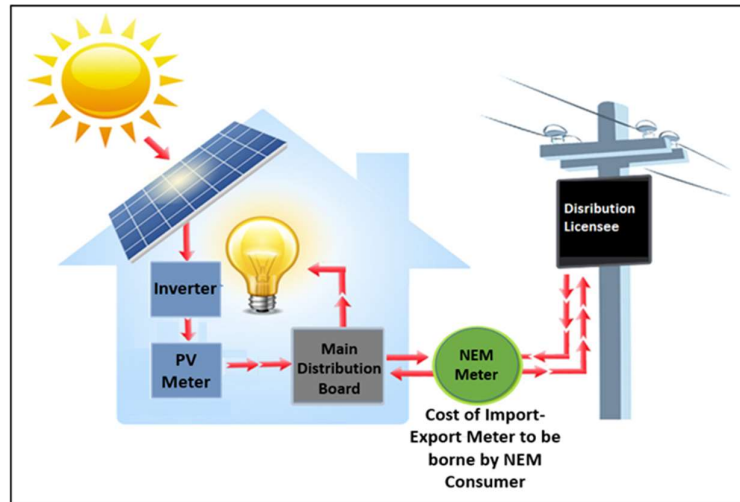

Figure 1: The connection of a solar PV Installation to the Consumer electrical Installation

9. NET ENERGY METERING ASSESSMENT STUDY (NEMAS)

- 9.1 The study shall determine the technical impact of the solar PV Installation to the Distribution Licensee's Distribution System and establish technical and safety requirements that may be necessary for the Installation.
- 9.2 The study is a pre-requisite for approval of the NEM 3.0 Programme application and as such, the study shall be performed and the study report shall be submitted prior to the approval of the NEM programme application. The findings of the study shall be used to assist the Distribution Licensee to decide on the feasibility of the project to be connected to Distribution System.
- 9.3 The study shall also be used by the Distribution Licensee to prepare the technical requirements or necessary modifications to the Distribution Licensee's Distribution System for connection of the PV Installation to the Distribution System.

9.4 The Consumer shall engage with the Distribution Licensee or any party approved by the Commission to conduct NEMAS for Installation above 72 kW. Upon request by the Consumer, Distribution System data shall be provided by Distribution Licensee subject to signing off a Non-Disclosure Agreement (NDA) between the party that shall perform the NEMAS and Distribution Licensee, if required by the Distribution Licensee. The assessment conducted shall be based on the Consumer’s load profile which shall include, but are not limited to:

- (a) a general description of the electrical supply system and connection of solar PV Installation;
- (b) a system study from the Consumer’s side to the Point of Interconnection;
- (c) an analysis on voltage, current, fault level and power factor impact to the Distribution Licensee’s Distribution System; and
- (d) any other analysis required by the Distribution Licensee for the purpose of safety and security of the Distribution System and other electricity Consumer.

All NEMAS conducted by qualified consultants shall be presented to the Distribution Licensee prior to any approval of the NEM 3.0 Programme application.

9.5 The costs of any works required for the connection of the solar PV Installation to the Distribution System shall be borne by the NEM Consumer.

9.6 Each study shall be valid for one (1) year commencing from the date of the Distribution Licensee’s approval of the study.

9.7 The fees for study shall be not more than the figures as shown in **Table 1**.

Installed Capacity (kW)	Study Required	Fees for Study
1 – 72 kW	No	-
> 72 kW – 180 kW	Yes	RM 1,000
> 180 kW – 425 kW	Yes	RM 5,000
> 425 kW – 1MW	Yes	RM 8,000

Table 1: Fees For Study

9.8 For capacity of not more than 72 kW, there shall be no analysis by the Distribution Licensee, and the Consumer shall ensure that the exported power shall be less than the existing capacity of the Distribution Licensee and Consumer's equipment. In ensuring compliance of the above, the Consumer shall provide appropriate functionality within the inverter or use of external device.

10. TECHNICAL REQUIREMENTS

10.1 The equipment, design, Installation, testing and commissioning, and the operation and maintenance of the solar PV Installation shall comply with the Energy Laws and any other relevant legal and regulatory frameworks issued by the Commission and any other authorities with jurisdiction over the Installation and operation of the solar PV Installation.

10.2 The NEM Consumer shall refer to the Technical Guideline for Connection of Indirect Solar PV Power Generation for NEM as in **Schedule 1** for relevant technical requirements and specifications of design, equipment, Installation works, testing, commission and operation of the solar PV Installation and the interconnection facility.

10.3 The design, calculation, drawings, Installation, testing and commissioning of the PV Installation and the interconnection to the Distribution System shall be certified by qualified and competent persons, as required under relevant laws, which include but shall not be limited to the following:

- (a) in accordance with the Energy Laws for electrical works; and
- (b) in accordance with the Registration of Engineers Act 1967 or Architects Act 1967 for the structure of mounting the PV panels.

10.4 The Distribution Licensee shall have the right to disconnect supply at the Point of Interconnection in the event of any danger or risk to the safety, reliability or security of the Distribution System or the safety of the NEM Consumer's Installation which the solar PV Installation may cause.

10.5 Provided that the solar PV Installation shall be reconnected to the Distribution System as soon as possible if such danger or risk has ceased or has been alleviated.

- 10.6 Provided further that no supply to the Premise of the NEM Consumer shall be disconnected unless under circumstances provided for under the Energy Laws.
- 10.7 Battery energy storage system is allowed for the PV Installation.
- 10.8 The PV Installation shall be equipped with smart inverter features as described in **Schedule 1**.
- 10.9 The NEM Consumer shall be responsible for safe operation and maintenance of the solar PV Installation in its Premise up to the Point of Interconnection of the Distribution Licensee's supply line.
- 10.10 The supply line and equipment beyond the Point of Interconnection and the metering facilities for measurement of Energy supplied by and exported to the Distribution System shall be the responsibility of the Distribution Licensee.
- 10.11 The offset part of electricity bills will be for a period of ten (10) years on commencement of the NEM Contract. Within the period, the Consumer is allowed to roll-over any excess Energy generated for every twelve (12) months. After the ten (10) years period, the solar PV Installation shall be strictly for self-consumption in the Premise where the solar PV Installation is installed, and no offset and roll-over will be allowed nor for any excess Energy to be exported.

11. METER INSTALLATION, TESTING AND COMMISSIONING

- 11.1 The NEM meter shall be able to measure and record Energy exported by the NEM Consumer to the Distribution Licensee and Energy supplied by the Distribution Licensee to the NEM Consumer. The NEM Consumer shall submit its application to the Distribution Licensee to check the existing meter prior to commencement of the NEM 3.0 Programme. The NEM meter shall be supplied and installed by the Distribution Licensee.
- 11.2 The reading of the NEM meter and the PV meter shall be prima facie evidence of the amount of Energy imported, exported or produced. The meter reading taken by the Distribution Licensee shall form the basis of any commercial settlement as provided for under the Act and the Licensee Supply Regulations 1990.

- 11.3 The Installation, usage, reading, checking, testing, recovery of charges and any other matters relating to the metering and billing arrangement shall be in accordance with the Act and the Licensee Supply Regulations 1990.
- 11.4 The testing and commissioning of the solar PV Installation shall be in accordance with the requirements under the Electricity Regulations 1994.
- 11.5 The NEM Contract is deemed to commence upon the acceptance by the Distribution Licensee of the testing and commission report submitted by the NEM Consumer and installation of the NEM meter by the Distribution Licensee.

12. MATTERS RELATING TO PRICING AND TARIFF

- 12.1 Under the NEM 3.0 Programme, the credit to the NEM Consumer shall be based on prevailing Energy rate in kWh in the gazetted tariff for the NEM Consumer. The calculation for the net charge amount of Energy shall be based on the following calculation and shall not be used to off-set the minimum monthly charge as stated in the tariff category of the Distribution Licensee:

Net charge amount (RM) = (Energy imported from Distribution Licensee* x prevailing gazetted Energy rate) – (Energy exported to Distribution Licensee x prevailing gazetted Energy rate)

*Energy imported is subjected to SST, KWTBB, ICPT, where applicable.

- 12.2 The NEM 3.0 Programme is primarily for self-consumption of the NEM Consumer in the Premise. However, during the first ten (10) years of operation under the NEM Contract, any excess Energy which is not consumed due to operational constraints or monthly or seasonal variation in load demands at the said Premise may be exported to the Distribution System. The credit to be received for such excess Energy may be used to offset part of the electricity bill for Energy provided by the Distribution Licensee during the applicable Billing Period. The net credit shall be allowed to roll over for a

maximum of twelve (12) months within the Settlement Period. Any available Energy after the period shall be forfeited.

- 12.3 No roll over of credit for any excess Energy will be allowed after the ten (10) years period as stated in clause 10.11 of these Guidelines.

13. ENERGY ACCOUNTING AND SETTLEMENT

- 13.1 The Energy accounting and settlement procedure for the NEM Consumer shall be as per the following procedures:

- (a) for each Billing Period, the Distribution Licensee shall show the quantum of Energy exported by the solar PV Installation in the Billing Period, quantum of Energy supplied by the Distribution Licensee in the Billing Period, net billed Energy for payment by the NEM Consumer for that Billing Period and net carried over electricity to the next Billing Period;
- (b) if the Energy exported exceeds the electricity consumed during the Billing Period, such excess exported electricity shall be carried forward to next Billing Period as electricity credit and may be utilized to net off electricity imported or consumed in future Billing Period but within the Settlement Period; and
- (c) if the electricity supplied by the Distribution Licensee during any Billing Period exceeds the electricity exported by the NEM Consumer, the Distribution Licensee shall raise invoice for the net Energy consumption after taking into account any electricity credit balance remaining from previous Billing Period.

- 13.2 The Distribution Licensee shall provide the following details with the electricity bill for each Billing Period:

- (a) the quantum of Energy exported to the Distribution System by the solar PV Installation;
- (b) the quantum of Energy supplied by the Distribution Licensee to the NEM Consumer;
- (c) the quantum of net Energy supply by the Distribution Licensee that is billed to the NEM Consumer for payment;
- (d) the quantum of Energy credits available to the NEM Consumer which is carried over from the previous Billing Period;
- (e) the quantum of Energy exported by the NEM Consumer to the Distribution System in excess of the electricity supplied by the Distribution Licensee

(quantum of electricity credits) which shall be carried forward to the next Billing Period; and

- (f) subject to any charges under the Electricity Supply Agreement between NEM Consumer and Distribution Licensee.

13.3 During any Billing Period, if the Energy exported exceeds the Energy imported, the net Energy shall be allowed to roll over for a maximum of twelve (12) months. Any available Energy after twelve (12) months shall be forfeited.

14. PROCEDURE FOR APPLICATION

14.1 Any application for the NEM 3.0 Programme shall be on a first-come-first-served basis up to the allocated capacity for each category or up to 31 December 2023, whichever comes first. The application shall be submitted to the Implementing Agency with supporting documents. An application fee of RM10 per kW will be charged for an application by the NEM Consumer.

14.2 The Implementing Agency shall publish the NEM Rakyat and NEM GoMEn programmes, the available capacity for application up to the previous day, these Guidelines, the procedure of application and application form on its website. The Implementing Agency shall make copies of the procedure of application and application form to be provided to any Applicant for the NEM 3.0 Programme. The details of procedure and application form is attached in **Schedule 2**.

14.3 The Implementing Agency shall process and verify the application, notify the Applicant whether its application is accepted, advice the Applicant to proceed with NEMAS if required, and provide the detail of the application to the Distribution Licensee within ten (10) days from the date of complete submission of application.

14.4 Upon being notified by the Implementing Agency on approval of the application, the Applicant shall commence to install the solar PV Installation within three (3) months from the date of the notification (date of notification inclusive), failing which, the application shall be deemed withdrawn and cancelled. Any processing fee paid shall not be refunded.

14.5 In the event the Applicant decides to withdraw the application after submitting the application, the application fee shall not be refunded.

15. NEM CONTRACT

15.1 The NEM Consumer shall sign a NEM Contract with the Distribution Licensee before the commencement of operation of the NEM Rakyat and the NEM GoMEn programmes. A sample of the NEM Contract is attached in **Schedule 3**.

16. CHANGE OF OWNERSHIP

16.1 In the event a NEM Consumer sells the Premise registered under the NEM Rakyat or the NEM GoMEn programme, the new owner of the Premise may apply to continue with the programme for the remaining duration of the period of operation under the NEM Rakyat or the NEM GoMEn programme.

16.2 The NEM Rakyat and the NEM GoMEn programmes may only be continued with the execution of a new NEM Contract between the Distribution Licensee and the new owner.

16.3 NEM Consumer(s) shall not be entitled to transfer any credit amount to any accounts of other NEM Consumer(s) or any third-party account(s). The new NEM Contract shall be signed between the Distribution Licensee and the NEM Consumer upon the transfer of the PV Installation.

16.4 All costs and expenses for the transfer of the solar PV Installation shall be borne solely by the NEM Consumer.

17. LICENSING REQUIREMENT

17.1 Licence is required under Section 9 of the Act for any person to use, work or operate or permit to be used, worked or operated a solar PV Installation above 72kWp for three (3) phase system and above 24kWp for single phase system. The NEM

Consumer or the owner of the PV system asset shall apply for a licence from the Commission after receiving information that the application has been approved.

17.2 For licensing purposes, the Guidelines on Licensing Under Section 9 of The Act [Electricity Supply Act 1990 (Act 447)] is available on the Commission's website www.st.gov.my and an application shall be made online via oas.st.gov.my link.

17.3 Notwithstanding paragraph 17.1 and 17.2, any person exempted from the licensing requirements under section 9 of the Act pursuant to the Notification on Exemption Under Section 54 [P.U.(B) 342/2008] shall complete a form as attached in Attachment 1 and return the same to the Commission no later than twenty-eight (28) days after it is notified of its approval as a NEM Rakyat and/or a NEM GoME Consumer by the Distribution Licensee.

18. ENVIRONMENTAL ATTRIBUTE

18.1 The value of any credits or financial benefits which are available or may become available for reductions of "greenhouse gas" emission earned from the generation of solar PV Energy by solar PV Installation shall be solely for the benefit of NEM Consumer.

19. NOTICE BY THE COMMISSION

19.1 The Commission may issue written notices from time to time in relation to implementation of these Guidelines.

SCHEDULE 1



Technical Guideline for Connection of Indirect Solar PV Power Generation for Net Energy Metering (NEM 3.0)

January 2021

CONTENTS

Chapter	Page
1.0 Overview.....	2
2.0 Scope.....	4
3.0 Glossary	5
4.0 Description of Indirect Solar PV Power Generation.....	7
5.0 Connection Scheme	8
6.0 General Requirements	10
7.0 Penetration Limit	16
8.0 Protection Guidelines.....	17
9.0 Metering.....	21
10.0 Safety Requirements	22
11.0 Application Process	23
12.0 Testing & commissioning	26
13.0 Operation and Maintenance.....	27
14.0 Other Requirements	28
ATTACHMENT A : Smart Inverter Functions.....	29

1.0 Overview

1.1 Introduction : Connection of Solar PV generation system to the customers' internal system under the implementation of Net Energy Metering, requires a review of existing connection scheme and requirements.

The internal generation by the customers in aggregate would impact the Distribution system behaviour, especially when there is excess of generation from the customer. Due consideration of the impacts must be taken to mitigate the problem caused by the internal generation for example voltage rise, safety, power quality etc.

RE developers, service providers, operators and parties otherwise involved in the installation and commissioning of PV generation to the grid can utilise these guidelines for:

- a) Reference to issues related to grid connection of PV.
- b) Finding out the power quality requirements for PV interconnection with medium and low voltage distribution networks.
- c) Understanding the interconnecting requirements whether for small, intermediate or large PV systems.
- d) Finding out the methods available for interfacing of the PV generator to the grid system (connection schemes), including the compliance requirements for energy metering and SCADA.
- e) Understanding the practices to ensure the safety of the personnel and equipment involved in utility-connected PV operations.

1.2 Regulations : Paralleling indirect Solar PV power generation system to the grid shall be subjected to compliance to the prevailing electricity supply rules & regulations to ensure adherence to the standard practices, quality of supply and personal & public safety.

Regulating authority is Suruhanjaya Tenaga Malaysia.

The following document shall be referred in determining the compliance to operational conditions terms:

- a) Electricity Supply Act & Regulations
- b) The Malaysian Distribution Code

For customers connected to Distributor licensee system, connecting indirect Solar PV power generation system internally requires compliance to requirements stated in this document. Power generated from indirect Solar PV power generation system is potentially able to disrupt the existing network quality, security & safety.

Without proper consideration, connecting indirect Solar PV power generation system could result in:

- a) Voltage fluctuation
- b) Voltage rise
- c) Voltage unbalance
- d) Overloading of existing grid connecting feeder/cable
- e) Power Quality issues
- f) Islanding
- g) Coordination with other on-site generations such as backup generator, co-gen and energy storage system

1.3 Boundary of ownership and responsibilities

Boundary and responsibility limits of Distribution Licensee & NEM consumer must be clearly demarcated, agreed and documented.

Distribution Licensee responsibility is up to the metering point which is as the normal distributor customer boundary.

1.4 Approvals & license to build & operate

The consumer shall acquire the appropriate approval from relevant authorities and employ competent personnel to design the installation which include:

- Permit by local authority
- Permit by respective regulatory bodies
- Competent installer under regulation
- Competent operator
- Repair & maintenance

2.0 Scope

- 2.1 Scope**
- The main objective of this guideline is to provide guidance on the technical requirements for customers connected to the Distribution system who plan to install indirect Solar PV generation.
- This guideline outlines technical requirements to ensure that connection of the indirect Solar PV power generation system would be standardised in terms of scheme, devices, operation & limits. The ultimate objective is to harmonise indirect Solar PV power generation system with the existing supply network, neighbouring customer and other Distributed Generators (DG) within the same distribution network. Connection of indirect Solar PV power generation system should not cause breach of power quality, reliability and security of the network and safety of the operators and public.
- This guide covers requirements for connection of indirect Solar PV power generation system to the customer internal system. Power generation include:
- a) Indirect connection solar photovoltaic
 - b) Battery Energy Storage System (BESS)
- Limit of capacity for the indirect Solar PV power generation system under this guideline is up to 60% of fuse rating (for direct meter) or 60% of current transformer rating for LV consumers and 75% of maximum demand for MV customers.
- 2.2 Commercial matters**
- Commercial matters are not part of this guideline.
- 2.3 Application process**
- Customers that intend to install indirect Solar PV power generation system are required to register with the Distribution licensee. Registration to Distribution licensee is a statutory requirement as the consumer has altered the system registered during initial application.
- The application process and procedures are described in the “Guidelines For Solar Photovoltaic Installation on Net Energy Metering Scheme”.

3.0 Glossary

Demand	:	The demand of MW or MVAR of electricity (i.e. both Active Power and Reactive Power respectively) unless otherwise stated.
Direct Connection	:	Connection of Solar PV power generation system directly to the distribution system.
Indirect Connection	:	Connection of Solar PV power generation system to the consumer owned internal network.
Distribution licensee	:	The holder of a license to distribute issued by Energy Commission under Section 9 of the Electricity Supply Act 1990.
Distribution System	:	The system of electric lines with voltage levels below 66 kV, within the Area of Supply owned or operated by the Distributor licensee/Embedded Distributor licensee, for distribution of electricity from Grid Supply Points or Generating Units or other entry points to the point of delivery to Customers or other Distributor licensees and includes any electrical plant and meters owned or operated by the Distributor licensee/ Embedded Distributor licensee in connection with the distribution of electricity .
Harmonic	:	A sinusoidal component of a periodic wave or quantity having a frequency that is an integral multiple of the fundamental frequency.
Inverter	:	A machine, device, or system that changes dc power to ac power.
Islanding	:	A condition in which a portion of the utility system that contains both load and distributed resources remains energized while isolated from the remainder of the utility system.
Low Voltage	:	A voltage less than 1,000 volts or 1 kV.
Medium Voltage	:	A voltage exceeding 1 kV but not exceeding 50 kV.
Connection point	:	The point where indirect Solar PV power generation system is connected to the network.
Point of common coupling/ Interconnection	:	The point of connection between utility system and consumer.

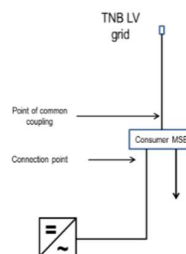

Total Harmonic Distortion (THD)	:	Harmonic distortion is the departure of a waveform from sinusoidal shape that is caused by the addition of one or more harmonics to the fundamental. Total Harmonic Distortion is the square root of the sum of the squares of all harmonics expressed as a percentage of the magnitude of the fundamental.
Type Test	:	Test of one or more devices made to a certain design to demonstrate that the design meets certain specifications.
Power Factor	:	Power factor (PF) is calculated by dividing the Real Power, P, in the W unit by the Apparent Power, S, in the VA unit.
Load profile	:	24-hour, 4-day profile (consisting of Friday to Monday) of customer electricity demand profile which include voltage, kW, kVar for 30-minute sampling
Net Energy Metering (NEM)	:	Customers with own generation whose solar PV installed capacity is for self-consumption. In the event of excess of generation, the energy is allowed to be exported to the grid.
Self-Consumption (SC)	:	Customers with own generation with installed capacity solely for self-consumption. In the event of excess of generation, the energy is not to be exported to the grid.
Peak Demand	:	Highest demand recorded in the load profile submitted during application for SG
Trough load/ Base load	:	Lowest demand recorded in the load profile submitted during application for SG
Battery Energy Storage System (BESS)	:	An energy storage system that employs battery technology for delayed applications. BESS described in this guide is used at the customer side, for the main purpose of enhanced electricity supply and integration with renewables.
Customer With Own Generation (CWOOG)	:	Term used in the MDC to categorise customers that have in-house power generation facilities that operate in parallel with the Distributor licensee distribution system. In relation to this guide, NEM consumer are those existing Distributor licensee registered customer with declared power generation facility.
Power limiting device	:	A device that is used to curtail export of excess energy to Distributor licensee's distribution system. The device could be integrated within the inverter or external.
Declared Annual Availability (DAA)	:	Annual quantity (in MWh) of renewable energy to be generated by the indirect Solar PV power generation system for each year. This information is to be furnished by NEM consumer to the Distributor licensee annually according to the agreed procedure.
Indirect Solar PV power generation	:	Power generation that utilize the solar photovoltaic technology to provide for the consumer's own demand. The indirect Solar PV power generation system is connected within the system and operate in parallel with the Distribution Licensee distribution system. Battery energy storage system could be used as part of the system.

4.0 Description of Indirect Solar PV Power Generation

4.1 Description : Consumers may decide to install indirect Solar PV power generation system to reduce their import from the Distribution Licensee. The indirect Solar PV power generation system is installed within its own system. The connection scheme is described in Chapter 5 of this guideline.

4.2 Battery Energy Storage System (BESS) : Use of BESS could enhance the energy utilization. BESS converter operates in bidirectional – charging and discharging. The grid-connected inverter and BESS shall comply with connection requirements as stated in IEEE 1547.

4.3 Inverter requirements : Inverters to be paralleled to the Distribution Licensee's distribution system shall comply to the following standards and references, in term of design, operation and maintenance:

	Standards/ Guide	Scope
a)	MS 1873	Connection scheme of grid connected inverter
b)	IEC 61727	Photovoltaic systems – characteristics of utility interface
c)	IEEE 1547	Standard for Interconnecting Distributed Resources with Electric Power Systems <ul style="list-style-type: none"> ▪ This standard describes the connection requirements of various Distributed Resources to the utility network.
d)	Suruhanjaya Tenaga	"Distribution Code For Peninsular Malaysia, Sabah & F.T. Labuan"
e)	TNB	"Tenaga Nasional Berhad – Technical Guidelines for Interconnection of Distributed Generator to Distribution System, 2018"
f)	Suruhanjaya Tenaga	"Guideline For Solar Photovoltaic Installation on Net Energy Metering Scheme"
g)	TNB	"Technical Guideline for Connection of Indirect Solar PV Power Generation for Net Energy Metering"
h)	TNB	"Electricity Supply Application Handbook"

Only inverters that comply with the standards above are allowed to be operating in parallel with Distribution Licensee distribution system. Type test certifications could be used as prove of compliance.

4.4 Power limiting capability : The demand from the Distribution system will reduce due to own generation by NEM consumer or export of excess energy to distribution network by NEM consumer. This could disrupt the distribution system, resulting in voltage rise and reverse power flow. During such event, the inverter shall reduce its generation upon receiving command from the detection device.

5.0 Connection Scheme

- 5.1 Introduction** : The connection scheme clauses takes into the following considerations:
- Safety
 - Connection with least alteration to existing network
 - Cost
 - Compliance to regulatory requirements

- 5.2 Connection types** : The types of connection for indirect Solar PV power generation system are as follows:
- Type A – for LV customers
 - Type B – for MV/HV customers

Assumption is made based on inverter output at low voltage level.

- 5.3 Feedings method** : The connection method of Solar PV power generation system can be categorised as:

- a) Direct Feed – Connection point at Distribution Licensee’s grid

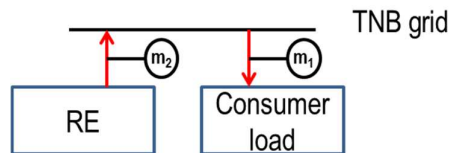

Fig. 5.1: Connection to Distributor licensee grid

Connection point is at the Distribution Licensee’s system. This method is adopted for Feed-in Tariff connections. Power consumption and power generation are segregated and measured independently by meters m1 and m2 respectively.

- b) Indirect Feed - Connection point at consumer

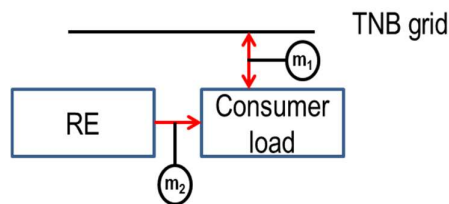

Fig. 5.1: Connection to TNB grid

Connection point is within the consumer’s network without direct connection to the Distribution Licensee’s system. This method is adopted for Net Energy Metering and Self Consumption schemes. Power consumption and export are measured by m1, while power generation is measured by m2. For net metering, meter m1 shall have bi-directional capability to register the import and export units. Meter m2 is a dedicated PV meter to record the generation from the indirect PV generation system and all costs relating to the PV meter shall be borne by the consumer.

**5.4 Type A:
LV customer
connections**

: Type A is applicable for Distribution Licensee's consumer with connection to LV network. PV connection point shall be done at the consumer's DB/MSB.

Use of a single phase inverter shall not cause unbalance conditions to Distribution Licensee's system. If such a condition is violated, requirement of a three phase inverter is automatically enforced.

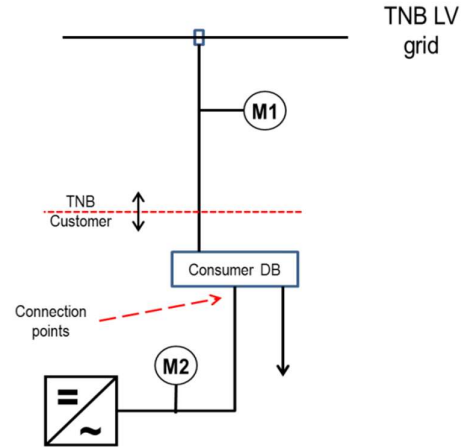

Fig. 5.3: Type A connection

Annual readings for M2 are to be furnished to Distribution Licensee.

**5.5 Type B:
MV customer
connections**

: Type B connection is applicable for Distribution Licensee's consumer with connection to MV network. PV connection point shall be done at the consumer MSB.

Use of a single phase inverter shall not cause unbalance conditions to Distribution Licensee's system. If such a condition is violated, requirement of a three phase inverter is automatically enforced.

Accumulated annual readings for M2 and M3 are to be furnished to Distribution Licensee.

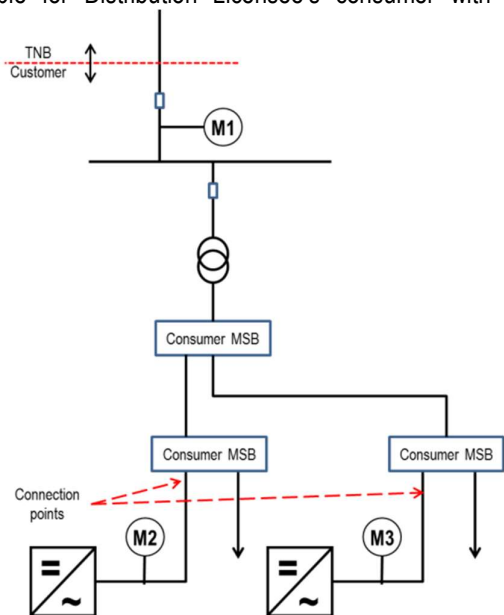

Fig. 5.4: Type B connection

6.0 General Requirements

- 6.1 Introduction** Connection of indirect Solar PV power generation system for NEM consumer shall be done internally which shall result in no requirement for upgrading of the existing utility supply infrastructure such as cable, fuse, switchgear, transformer and protection scheme.
- 6.2 Connection Requirement** As a result of installation of indirect Solar PV power generation system, the quality of power at the point of connection shall not be made worse than the existing quality of supply. Quality of supply is measured as compliance to the standards on voltage, flicker, frequency, harmonics and power factor. To ensure that the addition of indirect Solar PV power generation system does not adversely impact the quality of supply, the following requirements shall be imposed and adhered by the NEM consumer.
- Deviation from these standards represents out-of-bounds condition and may require the PV system to sense the deviation and properly disconnect from Distribution Licensee system.
- Power quality parameters (harmonics and voltage) must be measured at the utility interface/point of common coupling unless stated otherwise. At PCC, the power quality requirements must comply with Malaysian Distribution Code and this Technical Guidebook.
- 6.3 Selection of connection point** Although the connection of indirect Solar PV power generation system is within the consumer's premise, the following guides shall be satisfied to ensure that the connection does not interfere with the existing power supplied by the Distribution Licensee. The following items are to be considered during design.
- a) Customer load during peak and trough
 - b) Anti-islanding
 - c) Protection system
 - d) Step-up transformer (if applicable)
 - e) Interlocking
 - f) Back-up power supply (if applicable)
 - g) Energy storage system (if applicable)
 - h) Sensitive load
- During periods of low consumption (trough) and high generation from indirect Solar PV power generation system, consumer may experience reverse power flow. The NEM consumer is to ascertain that the internal network is capable of utilising all the generated energy and its protection system is able to cater for bi-directional power flow.
- 6.4 Connected Voltage** As the connection is done internally, NEM consumer shall appoint a qualified consultant to design the interconnection between indirect Solar PV power generation system and his existing plant.
- The interconnection shall comply with the standards as described in this guideline and other regulations issued by the Suruhanjaya Tenaga.

- 6.5 Installed capacity**
- Installed capacity of the system to be connected must be declared correctly during application. Except for NEM, other indirect Solar PV power generation system connection shall not result in export of power to the distribution system. Restriction of export is to ensure that the system voltage does not fluctuate so much during high load, low generation and low load, high generation. The installed capacity is declared in term of summation of MWp.
- The installed capacity of the indirect Solar PV power generation system shall be capped as below:
- a. Domestic consumers : up to 10kWac (4kWac for single phase and 10kWac for 3 phase systems)
 - b. Commercial, industrial and agricultural consumers :
 - i. For medium voltage consumers, the maximum capacity limit is 75% of maximum demand of the Consumer's current installation:
 - based on the past 1 year average of the recorded maximum demand of the consumer's installation; or
 - the declared maximum demand for consumers with less than 1 year.
 - ii. For low voltage consumers, the maximum capacity limit is 60% of fuse rating (for direct meter) or 60% of current transformer (CT) rating.
- The peak or maximum demand is to be supported by actual 24-hour, 4-day load profile consisting of Friday to Monday. The load profile with 30-minute reading interval. The capacity described above is total capacity for each site.
- 6.6 Export limiting**
- The export of excess energy from NEM consumer during its low demand and peak power generation could cause disruption to Distribution Licensee's network. Therefore, the amount of export is to be determined by the Distribution Licensee during the application process. For the capacity below 72kW, where there will be no analysis by the DL, the consumer shall ensure that the exported power shall be less than the existing capacity of the DL and consumer's equipment. Appropriate functionality within the inverter or use of external device to be provided to mitigate such a condition.
- Except for NEM consumer, no export is allowed. Appropriate functionality within the inverter, use of external device or energy storage must be provided. Feature and location of the function or device shall be specified in the application form & relevant drawings.
- 6.7 Boundary of ownership & operation**
- Boundary and operational limits of Distribution Licensee & NEM consumer must be clearly demarcated, agreed and documented. The Interconnection Operation Manual (IOM) shall be prepared and endorsed by both parties prior to the operation of the indirect Solar PV power generation system. Distribution Licensee's responsibility is up to the metering point which is as the ordinary Distribution Licensee's consumer boundary.
- 6.8 Equipment specifications**
- Major components of the indirect Solar PV power generation system shall comply to the following standard :
- a. MS 1837
 - b. IEC 61727
 - c. IEEE 1547

6.9 Normal Voltage Operating Range : The PV system injects current into utility and does not regulate voltage.

LV indirect Solar PV power generation system shall be capable of operating within the voltage range in Table 6.1.

Table 6.1: Normal operating condition at PCC (LV)

Nominal Voltage (V)	Steady state voltage limits
400	+10% and -6%
230	+10% and -6%

MV indirect Solar PV power generation system shall be capable of operating within the limits as in Table 6.2 below;

Table 6.2: Normal operating condition at PCC (MV)

Nominal Voltage (kV)	Steady state voltage limits
6.6	±5%
11	±5%
22	±5%
33	±5%

Table 6.1 and Table 6.2 are adopted from the “Malaysian Distribution Code”

6.10 Voltage fluctuation : Power generation from indirect Solar PV power generation system constantly varies due to the changing solar irradiation throughout the day. The varying power generation injected into the Distribution Licensee’s network is bound to create voltage fluctuations at the interconnection point and other buses within the grid.

The maximum voltage fluctuation range allowed for LV and MV due to varying solar radiation is 6%. Beyond this, there is a danger of utility and consumer equipment getting heated up.

An appropriate voltage control is to be undertaken to mitigate the voltage fluctuation when necessary.

6.11 Harmonic

The harmonic of a wave is a component frequency of a wave that is an integer multiple of the fundamental frequency. In the presence of non-linear loads such as computer power supplies and other appliances, alternating current (AC) can be distorted by introduction of various harmonic frequencies. Harmonics can be measured by percentage of the fundamental frequency or by calculating total harmonic distortion (THD). When present at high levels; these harmonics are detrimental to the electrical system and its loads.

The PV system output should have low current-distortion levels to ensure that no adverse effects are caused to other equipment connected to the utility system.

Total harmonic current distortion shall be less than 5 % at rated inverter output at cable connected to PCC. Each individual harmonic shall be limited to the percentages listed in Table 6.3.

Even harmonics in these ranges shall be less than 25 % of the lower odd harmonic limits listed.

Table 6.3 – Current distortion limits (IEC 61727-2003 Table 1)

Odd harmonics	Distortion limit (%)
3 – 9	< 4.0
11 – 15	< 2.0
17 – 21	< 1.5
23 – 33	< 0.6

Even harmonics	Distortion limit (%)
2 – 8	< 1.0
10 – 32	< 0.5

Note:

- *The harmonic current injection should be exclusive of any harmonic currents due to harmonic voltage distortion present in the utility grid without the PV system connected.*
- *Type tested inverters meeting the above requirements should be deemed to comply without further testing.*

6.12 Inverter Power Factor

The power factor is defined as the ratio between the applied active power and the apparent power.

PV systems shall have a leading or lagging power factor greater than 0.9 and 0.85 respectively when the output is greater than 20 % of the rated inverter output power. The smart inverters used shall automatically make necessary adjustments to ensure that the power factor does not cause voltage rise beyond the permissible limit.

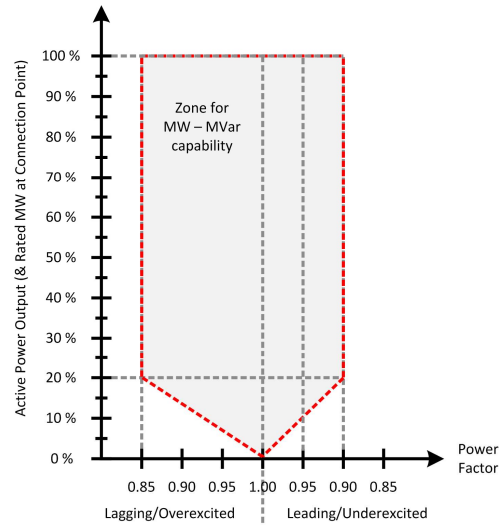

Fig. 6.1: Reactive power requirement at connection point

6.13 Reactive Power Compensation

Consumer should be aware that if the installed indirect Solar PV power generation system is set to operate at unity power factor, reactive power for their load will be totally imported from Distribution Licensee and real power will be mixed of own generation and import from Distribution Licensee.

This will result in low power factor reading at Distribution Licensee tariff meter as the ratio of reactive power to active power is higher with own generation.

Therefore, customer is advised to consult their service provider to provide internal compensation to avoid from being penalised.

6.14 DC Injection

The PV system shall not inject DC current greater than 1 % of the rated inverter output current into the utility interface under any operating condition.

6.15 Flicker

Flicker is due to rapidly changing loads that cause fluctuate in the customer's voltage. Even a small change in voltage can cause noticeable. Flicker is an irritation issue.

The operation of the PV system should not cause voltage flicker in excess of values stated in Table 6.4;

Table 6.4– Reference: TNB LV Planning Guidelines

Distribution system voltage level which the fluctuating load is connected	Absolute short term flicker severity (Pst)	Absolute long term flicker severity (Pit)
LV Systems	1.0	0.8
11kV – 33kV	0.9	0.7
Above 33kV	0.8	0.6

6.16 Voltage unbalance

Voltage unbalance is defined as the ratio of the negative sequence voltage component to the positive sequence voltage component.

Negative Phase Sequence Voltage (%): 2% for 1-minute duration when multiple single-phase PV units are installed and it should be distributed evenly among the three phases of the power system.

Infrequent short duration peaks with a maximum value of 2% are permitted for Voltage Unbalance.

The unbalance voltage shall not exceed 1% for 5 occasions within any 30-minute time period at the terminals of a user's installation.

6.17 Short circuit level

By regulation, Distribution Licensee is required to ensure that short circuit level of the network is within the equipment ratings. The regulation specifies that network maximum sub-transient 3-phase symmetrical short circuit shall be within 90% of the equipment designed short-time make & break capacity. Table 6.5 highlights the typical equipment ratings in Distribution Licensee's distribution network.

Table 6.5– Typical Equipment ratings in TNB Distribution Network

Nominal Voltage [kV]	Rated Voltage [kV]	Fault Current [kA]
33	36	25
22	24	20
11	12	20
0.4	1.0	31.5

7.0 Penetration Limit

7.1 Introduction

NEM consumers are allowed to export any excess energy to TNB, provided that the exported power are within the capacity of the existing equipment (TNB and consumer) and the voltage levels are within the limit.

Generation power limiter is necessary to ensure that during periods of low load and high solar generation, the local voltage level would not rise beyond the limit and the exported power are still within the capacity of the existing equipment (TNB and consumer)

7.2 Individual penetration

a) Net Energy Metering (NEM)

Applicable for Distribution Licensee registered consumer only. Consumer should decide on the installed capacity with consideration of their own daytime peak demand. Maximum installed capacity as shown in Table 7.1.

Table 7.1– Maximum installed capacity allowed for NEM customer

Category	Maximum capacity installed	
Domestic	Single phase Three phase	4kWac 10kWac Exported power to TNB shall be less than the existing capacity of TNB and consumer's equipment
Commercial, Industry and agricultural	MV Consumer	75% of consumer's maximum demand
	LV Consumer	60% of fuse rating for direct meter or 60% of CT rating

However, periodically, during low household power consumption period and high solar PV generation, the excess power is to flow into the grid.

b) Self-Consumption

Self-consumption means that the generated power is fully consumed within the customer premise. No export is allowed, therefore self-consumption consumer shall install a device that will prevent the export. The export curtailment is to prevent any voltage rise at the point where the indirect Solar PV power generation system is connected to the consumer MSB.

Limit for installed capacity is similar to that of NEM which refer to table 7.1 above.

c) BESS

Installed capacity of BESS should not cause any export to Distribution Licensee's grid. Appropriate limiting device must be emplaced.

8.0 Protection Guidelines

- 8.1 Introduction** : Protection system for indirect Solar PV power generation system is to be designed to isolate the faulty from the healthy sections of the system.

DG protection scheme is under NEM consumer responsibility and NEM consumer is to declare the protection scheme and settings to Distribution Licensee. NEM consumer shall design a protection system that fits his target degree of system security. Nonetheless, NEM consumer shall comply to Distribution Licensee's protection requirements to ensure that the fault would not spread beyond the plant.

NEM consumer is to perform protection coordination study to determine the suitable settings to protect the system during fault. Results of such study are to be furnished to Distribution Licensee for reference. Distribution Licensee shall advise NEM consumer on the appropriate settings at the point of common coupling.

For NEM consumer interconnection feeder protection scheme shall inhibit unsafe synchronization.

- 8.2 Smart inverter** : Connection of power generation to distribution network could cause voltage rise during low load, high generation condition. Also, sudden loss of generation from DG could cause instability of the network, especially for system with high DG penetration.

Advanced inverters or known as smart inverters are capable of providing additional features in addition to the power conversion. Smart inverters are PV inverters that stay connected and provide additional functions to help actively support the grid - mainly voltage and frequency. Traditional inverters simply disconnected when the grid voltage or frequency went out of range. Broadly, smart inverters provide some additional benefit to the grid beyond simply converting direct-current (DC) electricity to alternating current (AC) from PV systems. The smart inverter functions is outlined in the Attachment A.

- 8.3 Frequency** : Distribution Licensee shall maintain the system frequency and the PV system shall operate in synchronism with Distribution Licensee's frequency. Distribution Licensee shall operate with nominal 50 Hz system with $\pm 1\%$ range band.

- 8.4 Synchronisation** : Synchronisation is an act of matching, within allowable limits, the required DG parameters with the Distribution Licensee’s utility supply parameters as in Table 8.1.

Table 8.1– Parameters required for synchronisation

Parameters	Required range
a. Frequency difference	<0.2 Hz
b. Voltage magnitude difference	< 10%
c. Voltage angle difference	< 10 deg
d. Interlocking logic are satisfied	-

Synchronisation is to be done at the inverter. Re-synchronising is only to proceed once Distribution Licensee’s system is normalized and stabilized as in Table 8.2.

Table 8.2– Time taken for re-synchronising

Voltage	Time
LV	2 minute
MV	5 minute

- 8.5 Anti-islanding inverter** : Non islanding inverters are unable to supply the load without the presence of the Distribution Licensee’s system. For personnel safety reasons, PV plant is not allowed to be energized during outage of Distribution Licensee grid (loss of mains). The NEM consumer shall disconnect from the Distribution Licensee’s system for loss of main within 2 second.

Inverters used by NEM consumer shall provide the following anti-islanding detection techniques:

- a) Under Voltage
- b) Over Voltage
- c) Under Frequency
- d) Over Frequency
- e) 1 additional anti-islanding technique

NEM consumer is to prove the anti-islanding capability of the plant during commissioning tests.

- 8.6 Inverter Fault Detection** : PV system with inverter shall use abnormal voltage or frequency sensing for fault detection.

- 8.7 Inverter fault current contribution** : The fault current contribution by the inverter will be limited usually by inverter control. Based on IEEE 1547, the typical range of short circuit current is between 100% and 200% of the rated inverter current. NEM consumer shall ensure that inverters used comply to the IEEE1547 requirement.

- 8.8 Protection schemes** : The basic requirements for the design of the protection schemes shall be as follows:
- a) For any internal fault in the indirect Solar PV power generation system, the indirect Solar PV power generation system must not cause problems to the Distributor licensee system and its customers.
 - b) For any distribution network fault outside the indirect Solar PV power generation system plant, the PV system must be protected from any damaging effect.

NEM consumer shall be required to provide other protection devices to complement existing special features.

- 8.9 Failure of indirect Solar PV power generation system protection or control equipment** : Indirect Solar PV power generation plant must be disconnected from the distribution system during any of the system failure. Failure condition of indirect Solar PV power generation system equipment shall include:
- a) Failure of protection equipment
 - b) Failure of control equipment
 - c) Loss of control power

- 8.10 Voltage disturbance** : The inverter should sense abnormal voltage and respond according to the conditions in Table 8.3. Consideration shall be given to monitoring voltage in this clause in order to avoid problems due to voltage drop in various transformer, wiring or feeder circuit. When the inverter sense the voltage lies outside its operating limits, the recommended action shall be as in Table below.

Table 8.3– Voltage Disturbance

Voltage (at PCC)	Maximum trip time (s)
$V < 50\%$	0.10
$50\% \leq V < 90\%$	2.00
$90\% \leq V \leq 110\%$	Continuous operation
$110\% < V < 135\%$	2.00

Inverters are expected to continuously operate during distribution network voltage fluctuation $\pm 10\%$ of its nominal.

During the time of voltage disturbances which could be the result of transmission network switching and distribution switching on nearby feeder, the voltage would be affected. Therefore, inverters must be able to ride thru the voltage disturbance bands of 50% to 90% and 110% to 135%. This is to help stabilise the Distribution Licensee's system.

Loss-of-mains is indicated by voltage drop less than 50%.

Over voltage and under voltage detection shall be provided for all 3 phases.

- 8.11 Frequency disturbance** : The under frequency and over frequency levels and the corresponding inverter trip time shall be as follows:
- a) When the utility frequency is outside the nominal 50 Hz value by ± 1 %.
 - b) Trip time shall be within 0.20 s.
 - c) Applicable for both LV and MV interconnection.

- 8.12 Utility interface disconnect switch** : Indirect Solar PV power generation system interconnection must incorporate utility interface disconnect switch to allow disconnection of indirect Solar PV power generation system output from the interconnecting with Distribution Licensee for safe utility line works. The requirement of such switch could be referred to MS 1837. The switch shall be manual, lockable, load break disconnect switch that:
- a) Provide clear indication of switch position
 - b) Visible and accessible to maintenance and operational personnel
 - c) Provide visual verification of the switch contact position when the switch is in open position

- 8.13 SCADA** : The provision of SCADA together with RTU cubicle, associated cards and SCADA ready switchgear is mandatory for all DG plant interconnection of 1MW and above. SCADA equipment to be used is subject to the approval by Distribution Licensee.

The following parameters are to be made available for monitoring by the Distribution Licensee Control Centre:

- a) Voltage (V)
- b) Current (A)
- c) Real Power Energy Flow (kW or MW)
- d) Reactive Power Energy Flow (kVAR or MVar)

All interfacing wiring to be prepared by DG developer with Distribution Licensee supervision.

9.0 Metering

9.1 Introduction

Existing single phase and three phase whole current meter needs to be replaced to a bi-directional supply meter. The meter for large power consumer shall be replaced only if bi-directional register is required.

The existing meter board and its wiring (if required) to be re-located or to be replaced by the registered wireman appointed by the consumer. The location of the meter shall be assessable to TNB personnel, facing the main entrance and comply with the latest Electricity Supply Application Handbook.

The consumer shall bear all costs associated with the connection of indirect Solar PV power generation system including costs of meter replacement, supply upgrading, and system connection/modification (if applicable).

9.2 Energy meters

Energy meters are required to measure:

- a. The monthly Distribution Licensee-NEM consumer import & export (M1) for the purpose of net energy calculation. The M1 meter will be installed by TNB.
- b. The generation output energy from the indirect Solar PV power generation system (M2, M3). The M2/M3 meters will be installed by the consumer.

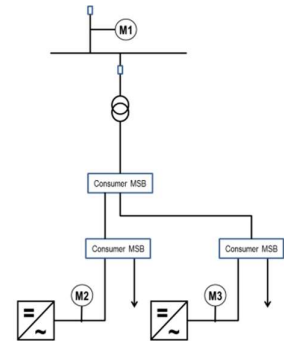

Fig. 9.1: Location of Energy Meters

9.3 Communication signal

Distribution Licensee uses wireless mode of communication between energy meter and HQ. Location of the meter room shall have adequate reception of the wireless signal to enable data transmission. NEM consumer shall provide a signal booster device whenever the communication signal is weak.

10.0 Safety Requirements

- 10.1 Introduction** The installation of grid-connected indirect Solar PV power generation systems shall comply with the requirements of MS IEC 60364 or MS IEC 60364-7-712. The provisions of this section are aimed at ensuring that these requirements are met, taking into account a range of system topologies and earthing arrangements.
- 10.2 Operation** It is important that for the safety of operating staff and public, both the Distribution Licensee and the NEM consumer operator must coordinate, establish and maintain the necessary isolation and earthing when work and/or tests are to be carried out at the interface/connection point.
- The safety coordination applies to when work and/or tests that are to be carried out involving the interface between the distribution network and the indirect Solar PV power generation system plant and it is the responsibility of the Distributor licensee and NEM consumer operator to comply with the requirements of statutory acts, regulations, sub – regulations, individual license conditions, Standardized Distributor licensee’s Safety Rules and the Malaysian Grid Code.
- 10.3 Interconnection Operation Manual** Interconnection Operation Manual (IOM) is to be prepared by the NEM consumer for indirect Solar PV power generation system >425kW.
- 10.4 Labelling** Labels shall be clearly placed to remind the operator that the device should be access cautiously as there could be an energised part that comes from the indirect Solar PV power generation system.

Test before touch must be practiced.



11.0 Application Process

11.1 Introduction

All indirect Solar PV power generations system with generation capacity of above 100kWp shall perform NEM Assessment Study (NEMAS) with Distribution Licensee or qualified consultant prior to NEM application to Implementing Agency.

The purposes of the assessment are for the following benefits:

- assist NEM applicant to decide on the feasibility of the project in terms of cost
- determine technical requirements needed for interconnection
- safety

NEM consumer is required to submit an application to MyTNB Portal (<https://www.mytnb.com.my/>)

11.2 Technical information

The following technical information is required to make assessment of the proposal.

	NEM > 72kW	BESS
Project information		
Applicant identity	✓	✓
Information of project	✓	✓
Design		
SLD ¹	✓	✓
Installed capacity	✓	✓
Declared Annual Availability	✓	✓
Expected commissioning	✓	✓
Equipment datasheet		
Inverter/converter datasheet	✓	✓
Battery datasheet	✓ ²	✓
Wind turbine datasheet	x	x
Prove of anti-islanding compliance	✓	✓
Power limiting device datasheet	✓	✓ ³
Penetration assessment		
Customer 4-day load profile consisting of Friday to Monday	✓	✓
Profile of Distributor licensee import-indirect Solar PV power generation system demand mix	✓	✓
Confirmation of zero export / limit (if required)	✓	✓
Other approvals		
Local authority	✓	✓
Structure	x	x

¹ SLD shall be endorsed by the Professional Engineer and qualified system designer

² Required if BESS is made part of the system

³ Exception could be considered if this feature is incorporated within battery management system

11.3 NEM Assessment Study (NEMAS) – for capacity above 72kW

The assessment conducted will be based on the Consumer's load profile which shall include, but are not limited to:

- (i) general description of the electrical supply system and connection of solar PV system;
- (ii) network study from Consumer side to the Point of Common Coupling;
- (iii) analysis on voltage and power factor impact to Distribution Licensee network;
- (iv) for capacity above 425kWac, fault analysis will be conducted; and
- (v) any other analysis required by the Distribution Licensee for the purpose of safety and security of the distribution network and other electricity consumer.

11.3 NEM Self-Assessment Study (for capacity below 72kW)

During application, self-assessment is required to determine the suitable capacity and connection requirements. Self-assessment study is to be done by the qualified personnel.

Contents of the study include:

- Adequacy – to ensure no export above the limit of equipment capacity
- Voltage rise
- Recommendation

12.0 Testing & commissioning

- 12.1 Introduction** : There are 2 types of testing required:
- a) Inverter compliance tests
 - b) Interconnection compliance tests

Inverter compliance test

NEM consumer is responsible to ensure that the inverter unit(s) are in compliance to the requirements of this guideline.

Certified results of tests must be submitted for verification.

Interconnection compliance tests

Prior to commissioning, the interconnection must be tested to ensure that the performance is up to the required standard, installations are according to the approved scheme, settings are done as approved, etc.

Connection of indirect Solar PV power generation system plant should not have detrimental impact to the operation of Distribution Licensee's grid.

Tests to prove the following items shall be carried out in the commissioning process:

- a) Anti-islanding on loss of mains,
- b) Interlocking scheme (if any)
- c) Equipment functional tests
- d) Power Quality measurement

- 12.2 Commissioning tests** Commissioning tests of the installation shall be carried out by the competent person appointed by NEM consumer.

All tests must be carried out by qualified testers.

Test equipment must have valid calibration certificate.

- 12.3 Commissioning of LV connection** For connections that are situated on a long feeder, special attention to the voltage level during peak and low load is to be made. Such a condition could result in excessive voltage rise during low load period.

13.0 Operation and Maintenance

13.1 Introduction

NEM solar PV installation is owned and maintained by the Consumer.

13.2 Boundary

Any failure of supply from TNB grid including the bidirectional meter shall be rectified and normalized by TNB.

Any failure of the consumer's electrical installation (after TNB meter) and solar PV system shall be rectified and normalized by the Consumer.

In the event of TNB supply failure, the Consumer has to ensure that there shall not be any reverse power/back feed from any internal source of generation (example solar PV, battery, generator) to TNB grid.

The Consumer is solely responsible for any accident/incident to human beings and equipment that may occur due to reverse power/back feed from any internal source of generation when the TNB grid supply is off.

TNB reserves the right to disconnect TNB supply to Consumer at any time in the event of default as specified in the NEM contract, damage to its grid, meter, etc, or to prevent accident or damage.

14.0 Other Requirements

14.1 Introduction : In addition to the technical requirements described in the previous sections, the following administrative requirements must be fulfilled.

Local authorities

- a. *Kebenaran Merancang* from the local authorities for overall plant.
- b. Building plan approval
- c. Site suitability

Regulator

- a. Generating license for capacity greater than 72kW from Suruhanjaya Tenaga
- b. Registration with authority for less than 72kW.

Land owner

- a. For tenants, written approval by the land owner shall be obtained.

The above list is not exhaustive.

ATTACHMENT A : Smart Inverter Functions

- Continued growth of PV generation puts more challenges on grid infrastructure designed for distribution from centralized energy sources. Advanced or smart inverter functions can help address the grid stability problems posed by high levels of variable distributed generation
- Smart inverters are PV inverters that stay connected and provide additional functions to help actively support the grid - mainly voltage and frequency. Smart Inverters able to receive commands from grid operators and report information. Traditional inverters simply disconnected when the grid voltage or frequency went out of range.
- Broadly, smart inverters provide some additional benefit to the grid beyond simply converting direct-current (DC) electricity to alternating current (AC) from PV systems. They typically support overall grid reliability by offering the following functions:

No.	Functions	Description	Setting	Reference
1	Anti-islanding Protection	<p>Automatically disconnect during grid failure within certain duration. The duration is adjustable.</p> <p>Anti-islanding protection is to ensure inverter doesn't back-feed a disabled grid</p>	<p>LV :</p> <ul style="list-style-type: none"> Disconnect 2sec Reconnect 2min <p>MV:</p> <ul style="list-style-type: none"> Disconnect 2sec Reconnect 5min 	<ul style="list-style-type: none"> Distribution Code: 7.8.3.5 - Protection and Control Requirements
2	Voltage and Frequency Ride-through Capability	<p>Inverter must meet the mandatory and permissive operation requirements as well as the must trip limits when the AC grid voltage and frequency high or low limits are exceeded.</p> <p>Inverters support the grid during brief voltage or frequency excursions. This function will help the grid to self-heal from a disturbance.</p> <p>During periods of (sometimes extreme) deviations in grid voltage and/or frequency, smart inverters are designed to remain connected to the grid and adjust their output to act as a counterbalance to frequency or voltage changes</p>	<p>LVRT/HVRT: Refer graph (Distribution Code)</p> <p>LFRT/HFRT: uninterrupted range 47Hz to 50.5Hz</p>	<ul style="list-style-type: none"> Distribution Code: 6.5.5.1 - Low Voltage Ride Through & 6.5.5.2 - Frequency disturbance
3	Ramp Rate Control	<p>The rate of power increase when first ramping (start ramp) and subsequent increases in offsetting or selling (normal ramp)</p> <p>To help smooth transitions from one output level to the next. Supports grid by ramping up slowly giving the grid time to adjust to the PV energy coming back online.</p>	<p>Does not exceed 15% of rated capacity per minute.</p> <p>Applicable for capacity of 5MW and above</p>	<ul style="list-style-type: none"> Grid Code: CC6.4.12

4.	Reactive Power Control Functions	<p>Inverter is able to supply or absorb reactive power to/from the grid to maintain stable grid voltage when fluctuations are prevalent.</p> <p>Variable Power Factor provides active voltage stabilization:</p> <ul style="list-style-type: none"> • Grid voltage nominal, purely active power • Grid voltage high, add 'inductive' reactive power • Grid voltage low, add 'capacitive' reactive power <p>Adjusting VARs keeps grid voltage from oscillating; acts like a shock absorber</p> <p>The reactive power control can be achieved using 3 main controls:</p> <ol style="list-style-type: none"> Dynamic Volt/VAr Mode (voltage control) Fixed power factor (pf control) Fixed reactive power (eg: using switched reactor or capacitor) 	<p>Voltage range:</p> <p>(MV-11kV&33kV) ± 5%</p> <p>(LV- 230V & 400V) -6% +10%</p> <p>Power Factor range: 0.85 lagging to 0.9 leading</p>	<ul style="list-style-type: none"> • Distribution Code: 5.4.4.1 - Voltage range, 6.5.5.5 - Reactive power, 7.8.3.8 - Power factor
5.	Active Power Control Functions Frequency-Watt (Droop Curve) and Volt-Watt	<p>Support grid frequency and voltage by changing inverter wattage output:</p> <p>Help to stable the grid during an under/over frequency and voltage event by controlling the real output of the solar system.</p> <ul style="list-style-type: none"> • Grid frequency/voltage nominal, inverter at max output • Grid frequency/voltage high, inverter curtails power • Grid frequency/voltage low, inverter increases power 	<p>Frequency range: 47Hz to 50.5Hz</p> <p>Voltage range: (MV-11kV&33kV) ± 5%</p> <p>(LV- 230V & 400V) -6% +10%</p>	<ul style="list-style-type: none"> • Distribution Code: 6.5.5.4 - Droop curve, 5.4.41 - Voltage range & 6.5.5.3 - Power output management
6.	Data log/Memory card for event logs	<p>Capture profile of networks parameters – Voltage, Current, Frequency, Power (active & reactive), power factors and events log.</p> <p>The data log can be used for troubleshooting and monitoring purposes.</p>	N/A	Distribution Code: 6.8.1.3 - Distribution System Control Structure
7.	Remote monitoring and configurability	Able to control remotely using SCADA system (for capacity 1MW and above)	N/A	Distribution Code: 6.8.1.3 - Distribution System Control Structure

SCHEDULE 2

NET ENERGY METERING (NEM) APPLICATION WORKFLOW



Registered Consumer

NEM Applicant Checklist

- Check NEM eligibility**
 - TNB registered consumer or a Person applying to be a consumer of the TNB
 - Consumer without any Solar PV installation under previous solar PV programme
 - NEM Rakyat**: A domestic consumer occupying a private dwelling premise without carrying out any form of business
 - NEM GoMen**: A ministry, department or statutory body whether at federal, state, or district level including local authorities
- Check NEM category**
 - NEM Rakyat**
 - Domestic Tariff
 - NEM GoMEN**
 - Commercial Tariff

Note: Please refer TNB Tariff category
- Know Your Solar PV capacity limit**
 - NEM Rakyat**
 - ≤ 4 kWac for single phase system;
 - ≤ 10 kWac for 3 phase system
 - NEM GoMEN**
 - ≤ 1 MWac / 1 Account
 - For Medium Voltage : ≤ 75% of max. demand
 - For Low Voltage : ≤ 60% of fuse rating/ current transformer

- Check NEM Quota Availability**

Quota Allocation :

 - NEM Rakyat 100MW
 - NEM GoMEN 100MW

Go to www.seda.gov.my => Online System

Appoint Registered PV Service Provider (RPVSP)
 Go to www.seda.gov.my => Directory => 2021 Registered PV Service Providers.



Registered PV Service Provider (RPVSP)

Prior to NEM application (>72kW);

- NEM Assessment Study (NEMAS).

Submit NEMAS application

Yes (>72kW) → NEMAS Approval

No (≤ 72kW) → Prepare all information & documents required

- Prepare all information & documents required
- Information:**
- Applicant's Profile
 - Information of project
 - Technical information
 - Proposed work plan
- Documents:**
- Single Line Diagram (SLD) endorsed by Competent Person
 - Latest electricity bill
 - NEMAS Report (>72kW)
 - Document proving site ownership

Submit NEM application through eNEM (online)



Distribution Licensee

Installed Capacity	Study Required	Fee of Study (RM)
1-72 kW	No	-
>72 kW - 180 kW	Yes	RM1,000.00
>180 kW - 425 kW	Yes	RM5,000.00
>425 kW - 1 MW	Yes	RM8,000.00

NEMAS Approval

No → Prepare all information & documents required

Yes → NEM Approval

30 days

NEM Approval

Yes → Issue Certificate

No → Prepare all information & documents required

10 Days



SEDA Malaysia

After NEM Approval



Registered PV Service Provider (RPVSP)



Distribution Licensee



SEDA Malaysia

Issue Certificate

{Must submit within 3 months}

{Within 3 months for processing and approval}

- ST Public Generation License**
- Single phase -> 24kWp
 - Three phase -> 72kWp
 - Notification on Exemption Under Section 54, for person exempted from the licensing requirement (28 days from approval)

Start Installation

Submit photos to prove commencement of installation

Request for NEM meter

Check/change existing meter to bi-directional meter

NEM Contract signing

NEM billing

If Yes : Complete
 If No : Approval will be cancelled

SEDA to verify

Note: NEM Rakyat & NEM GoMEN Effective from 1st February 2021.

**NET ENERGY METERING (NEM) RAKYAT
APPLICATION FORM**

BORANG PERMOHONAN PEMETERAN TENAGA BERSIH (NEM) RAKYAT
NET ENERGY METERING (NEM) RAKYAT APPLICATION FORM



Sila kemukakan borang permohonan anda ke /
Please submit your application form to:
Sustainable Energy Development Authority Malaysia
Galeria PJH, Aras 9, Jalan P4W
Persiaran Perdana, Presint 4,
62100 Putrajaya, MALAYSIA

Untuk kegunaan pejabat sahaja /
For office use only:
Reference No. :
Serial No. :
Date Received :/...../.....
Time received :
Receiving Officer :

BAHAGIAN 1 : MAKLUMAT PEMOHON / SECTION 1 : APPLICANT INFORMATION
(BORANG INI HENDAKLAH DIISI DENGAN HURUF BESAR) / (THIS FORM TO BE COMPLETED IN CAPITAL LETTERS):

1A UNTUK PEMOHON INDIVIDU / FOR INDIVIDUAL APPLICANT

BUTIRAN PEMOHON / APPLICANT DETAIL

Gelaran/Salutation (Encik/Puan/Cik/Gelaran Lain _____)
(Mr./Mrs./Miss/Other Salutation)

Nama / Name

Kewarganegaraan / Citizenship

E-mel / E-mail: _____

No. Mykad: [] [] [] [] [] [] [] [] - [] [] [] [] [] []
Identity Card No. **atau / or**

No. Pasport (bagi bukan warganegara Malaysia) /
Passport No. (For non-Malaysian)

No. Tel / Tel. No.: _____ - _____

No. Tel. Bimbit / Mobile No. : _____ - _____

ORANG LAIN YANG BOLEH DIHUBUNGI / ALTERNATE CONTACT PERSON

Gelaran/Salutation (Encik/Puan/Cik/Gelaran Lain _____)
(Mr./Mrs./Miss/Other Salutation)

Nama / Name

Hubungan / Relationship: _____

Kewarganegaraan / Citizenship

No. Mykad: [] [] [] [] [] [] [] [] - [] [] [] [] [] []
Identity Card No. **atau / or**

No. Pasport (bagi bukan warganegara Malaysia) /
Passport No. (For non-Malaysian)

No. Tel / Tel. No.: _____ - _____

No. Tel. Bimbit / Mobile No. : _____ - _____

E-mel / E-mail: _____

1B UNTUK PEMOHON BUKAN INDIVIDU (jika berkenaan)/ FOR NON INDIVIDUAL APPLICANT (if applicable)

BUTIRAN PEMOHON / APPLICANT DETAIL

Nama Syarikat/ Organisasi/ Kementerian/ Jabatan/ PBT/ Company/ Organization/ Ministry/ Department
/ Local Authority Name: _____

No. Pendaftaran Syarikat/ Organisasi/ Badan Kerajaan (jika berkenaan)/ Registration no. for Company / Organization
/ Government body (if applicable): _____

Registration No./ School or e-PBT No. (untuk PBT / for local authority) : _____

Tarikh ditubuhkan / Date of incorporation : [] [] [] - [] [] [] - [] [] [] [] [] []

Alamat Berdaftar / Registered Address : _____

Poskod / Post Code [] [] [] [] Bandar / Town _____ Negeri / State _____

Alamat Perniagaan/ Surat-Menyurat (jika berlainan) / Business/ Mailing Address (if different) : _____

Poskod / Post Code [] [] [] [] Bandar / Town _____ Negeri / State _____

No. Tel (P) / Tel (O) No. [] [] [] [] [] [] [] [] - [] [] [] [] [] [] No. Faks (P) / Fax No. (O) [] [] [] [] [] [] [] [] - [] [] [] [] [] []

E-mel / E-mail _____ Laman Web / Website _____

ORANG YANG BOLEH DIHUBUNGI / CONTACT PERSON

Gelaran/Salutation (Encik/Puan/Cik/Gelaran Lain _____)
(Mr./Mrs./Miss/Other Salutation)

Nama / Name

Jawatan / Position :

Kewarganegaraan / Citizenship

No. Mykad: _____

Identity Card No. _____ atau / or

No. Pasport (bagi bukan warganegara Malaysia) /
 Passport No. (For non-Malaysian)

No. Tel / Tel. No.: _____

No. Tel. Bimbit / Mobile No. : _____

E-mel / E-mail: _____

BAHAGIAN 2 : MAKLUMAT PROJEK / SECTION 2 : PROJECT INFORMATION

2.1. ALAMAT PEPASANGAN/ INSTALLATION ADDRESS

Alamat Tapak Pemasangan / Site Installation address

Poskod / Post Code _____ Bandar / Town _____ Negeri / State _____

Pemilikan Tapak / Site Ownership : Dimiliki Sepenuhnya / Fully Owned Sendiri (Pajakan kepada bank) / Owned (Charged to bank) Sewa/ Leased "

Lokasi GPS Tapak Pemasangan / GPS Location of Site Installation:

Latitud / Latitude : _____ ° _____ ' _____ " Longitud / Longitude : _____ ° _____ ' _____ "

2.2 MAKLUMAT PEPASANGAN / INFORMATION OF INSTALLATION

Nama Pemegang Lesen Pengagihan / Distribution Licensee:

Kategori Tarif / Tariff Category :

Maklumat Bil (No. Akaun) / Billing Information (Account No.):

No. Kontrak/ Contract No. :

Sumber Tenaga Boleh Baharu / Renewable Energy Resources:

Kapasiti Terpasang Yang Diisytiharkan / Declared Installed Capacity :

Kapasiti Terpasang / Installed Capacity :

Adakah pemohon pernah menyertai mana-mana program fotovolta suria sebelum ini? Jika **Ya**, sila isi maklumat yang diperlukan di bawah/ Have the applicant participated in any of the prior solar PV programmes? if **Yes**, please fill in the required information below:

TENAGA NASIONAL BERHAD (TNB)											
Tarif A - Domestik Tariff/Tariff A - Domestic Tariff											
SOLAR PV											

_____ kWac
 _____ kWp

No.	Program/ Mekanisme Programme/ Mechanism	Kapasiti Terpasang Installed Capacity	Alamat pemasangan/ Installation address

2.3 MAKLUMAT PEMBEKALAN DAN PEPASANGAN / SUPPLY AND INSTALLATION INFORMATION

Tahap Voltan Pada Titik Sambungan Meter TNB Voltan Rendah (Satu Fasa)
 / Voltage level at TNB Meter Connection Point: Low Voltage (Three Phase)

Voltan pada Titik Gandungan Sepunya / Voltage at Point of Common Coupling : _____ Voltan / Voltage

Status Projek/Project Status: Projek Baru/New Project Projek Telah Siap/Completed Project
 Penambahan kapasiti/increase capacity

Jenis Bangunan / Types of Building: _____

Contoh: Rumah / Kedai / Office / Lain-lain / Example: House / Shop / Office / Others

Penggunaan Bateri Simpanan / Use of Battery Storage : Ya / Yes Tidak / No

*Jika **Ya**, sila kemukakan reka bentuk terperinci / If Yes, please provide detail design.

Kapasiti Bateri / Battery Capacity : _____ Jenama dan Model / Brand and Model: _____

Anggaran Penjanaan Tenaga Tahunan / Estimated Annual Energy Generation: _____ MWh/year

Anggaran Kerosotan Pemasangan / Expected Plant Deterioration: _____ %/year

2.4 MAKLUMAT TEKNIKAL / TECHNICAL INFORMATION:

Peralatan / Equipments	Jenama / Brand	Model	/ Quantity
a) Modul/ Module jenis / type (monocrystalline/ polycrystalline/ thin film/others)			
b) Penyongsang pintar / Smart Inverter			
c) Datalogger (Optional) *For capacity more than 72kWac will be required for T&C purpose			

2.5 PEMBEKAL PERKHIDMATAN SURIA FOTOVOLTA BERDAFTAR SEDA MALAYSIA / SEDA MALAYSIA REGISTERED PV

Nama Syarikat / Company's Name:

No. Pendaftaran Syarikat / No. Perniagaan:

Company Registration No. / Business Registration No.

Syarikat RPVSP berdaftar SEDA M'sia / SEDA M'sia's RPVSP company

 Ya / Yes

 Tidak / No

Jika Ya, No. Sijil Pendaftaran / If yes, Certificate Registration No.

Kontraktor Elektrik Berdaftar ST / ST's Registered Electrical Contractor

 Ya / Yes

 Tidak / No

Jika Ya, No. Sijil Pendaftaran / If yes, Certificate Registration No.

Alamat Pejabat / Office Address :

Poskod / Post Code

Bandar / Town

Negeri / State

No. Telefon/Telephone No.

No. Faks / Fax No.

E-mel Syarikat / Company E-mail :

Orang Yang Boleh Dihubungi / Contact Person :

Jawatan / Position :

No. Tel. Bimbit / Mobile No. :

E-mel / E-mail:

2.6 PENDAWAI (≤72kWac) / WIREMAN (≤72kWac)

Nama / Name

No. Mykad:

Identity Card No.

No. Tel. Bimbit / Mobile No:

Nama Syarikat

E-mel

/ E-mail

No. Sijil Pendaftaran ST / ST's Certificate Registration No.

BAHAGIAN 3 : MAKLUMAT PEMBIAYAAN / SECTION 3 : FINANCING INFORMATION**Capital Expendature****1 Equipment Cost:**

i. PV module	RM
ii. PV Inverter	RM
iii. Balance of system	RM
iv. Other Equipment cost (please state):	RM
Total Equipment Cost	RM

2 Installation Cost

i.	Consultancy and Design Cost	RM
ii.	Interconnection Cost	RM
iii.	Preliminary Cost	RM
iv.	Other Installation Cost (please state):	RM
Total Installation Cost		RM

3 Annual Operational Expenditure

i.	Insurance Premium	RM
ii.	Operation and Maintenance Cost	RM
iii.	Other operation Cost (Please state):	RM
Total Operating Cost		RM

Financial Model, please tick (/) whichever applicable:

- a. Outright/Direct Purchase
- b. Bank Loan
- c. Solar Leasing/Hire Purchase
- d. Solar Power Purchase Agreement (PPA)
- e. Hybrid of Solar Leasing and Solar PPA

For "Solar Leasing/Hire Purchase or Solar Power Purchase Agreement (PPA) or Hybrid of Solar Leasing and Solar PPA" system, please provide the information below:

- i. Registered Solar PV Investor:
- ii. Contract Period: Year
- iii. Repayment Method:
 - i. Repayment Amount (RM/kWh)
 - ii. Repayment Amount (RM/month)

BAHAGIAN 4 : JADUAL KERJA YANG DICADANGKAN / SECTION 4 : PROPOSED WORK PLAN

No.	Pencapaian / Milestones	Anggaran Tarikh Akhir / Estimated Due date
1	Tarikh Permohonan NEM dikemukakan / <i>NEM application submission date</i>	
2	Cadangan tarikh permulaan bagi kerja-kerja pemasangan sistem fotovoltia suria (dalam tempoh 3 bulan dari tarikh kelulusan NEM)/ <i>Proposed date for commencement of solar PV system installation work (within 3 months from the date of NEM approval)</i>	
3	Tarikh cadangan T&C bersama Pemegang Lesen Pengagihan bagi penukaran/menaiktaraf meter utiliti [jika perlu] / <i>T&C Proposal Date with Distribution Licensee for Changing/Upgrade Utility Meter [if required]</i>	
4	Tarikh Pentauliah NEM (Cadangan tarikh menandatangani kontrak NEM) / <i>NEM Commencement Date (Proposed date for signing of NEM contract)</i>	

BAHAGIAN 5 : SENARAI SEMAK DOKUMEN SOKONGAN / SECTION 4 : SUPPORTING DOCUMENTS CHECKLIST

Salinan bagi dokumen-dokumen berikut hendaklah dikemukakan bagi menyokong permohonan ini, yang mana berkenaan /
The following documents are to be submitted in support of this application, where applicable:

No.	Dokumen Yang Diperlukan / Documents Required	Sila [/] / Please [/]
1.0	Applicant Information:	
1.1	Individual	
	Applicant's MyKad (front and back) / Passport (if foreign person).	
	Company / Organization / Society / Government Body (if applicable)	
	Where applicable, the documents on (if any):	
	i) Company: Form 8 (Certificate of Incorporation of Public Company) or Form 9 (Certificate of Incorporation of Private Company) in connection with the Applicant under the Companies Act 1965;	
	ii) Organisation (Body Corporate): The certificate from the appropriate authority certifying that the body has been duly constituted under the said written law;	
	iii) Organisation (Society): The certificate of registration issued by the Malaysia Co-operative Societies Commission;	
	iv) Organisation (Firm): The certificate of registration (Form D) of the firm issued by the Registrar of Businesses; or the letter or certificate relating to the constitution of the firm from bodies regulating the profession in which the firm is practising in;	
	v) Organisation (Registered Society): The certificate of registration issued by the Malaysia Co-operative Societies Commission;	
	vi) Organisation (Care Centre): The certificate of registration of the care centre issued by the Social Welfare Department of Malaysia or the relevant religious authority;	
	vii) Organisation (Place of Worship): The certificate of registration of the place of worship issued by the relevant religious authority; or the certificate of registration of the society in charge of the place of worship issued by the Registrar of Societies and a letter from the relevant local authority confirming that the place of worship has duly obtained a certificate of completion and compliance or certificate of fitness or other applicable approval; or	
	viii) Organisation (Educational Institution): The certificate of registration of the educational institution issued by the Ministry of Education; or in the case of religious schools, the certificate of registration of the religious school issued by the relevant religious authority.	
	ix) Ministry/ government entities: Supporting documents with regards to the establishment of Government Agency	
2.0	Site Information:	
2.1	Documents proving the Applicant's ownership of the site, or other conditional or unconditional rights (e.g. letter or agreement) that the Applicant has to utilise/lease the site for a minimum period equivalent to the effective period	
3.0	Technical Information:	
3.1	The detailed engineering design of the renewable energy installation, including all relevant calculations to justify the installed capacity and claimed efficiencies, proposed plant layout and AC/DC single line diagram certified by relevant Competent Person under Electricity Supply Act 1990 and the regulations thereunder; and SEDA Malaysia Qualified Person (SEDA Malaysia GCPV System Design Certificate Holder)	
3.2	Product data sheet / technical parameter for all electrical components. Please provide rating of each electrical components (SPD, fuses, switches, PV modules, Inverters)	
3.3	If use battery storage, please provide detail design;	
4.0	Billing information:	
	Documentary evidence showing that applicant has applied to be a consumer of TNB or a copy of three (3) months electricity bill (latest);	
5.0	Competency Certificates:	
5.1	Competent Person certificates:	
	i) A certificate of registration as an Electrical Contractor issued by ST;	
	ii) A certificate(s) of Competency as a Wireman issued by the ST for each Competent Person's	

	5.2	SEDA Malaysia Qualified Person certificates:	
		i) A certificate of Competency in GCPV System Design issued by SEDA Malaysia for each Competent Person's	
		ii) A certificate of Competency as a Wiremen in GCPV System issued by SEDA Malaysia for each Competent Person's	
6.0	<i>Approval letter from Ministry of Education (for school only)</i>		
	<i>Others (Please specify):</i>		
	<i>i)</i>		
	<i>ii)</i>		
	<i>iii)</i>		

BAHAGIAN 6 : PENGISYTIHARAN BAGI PERMOHONAN NEM / SECTION 6 : DECLARATION FOR NEM APPLICATION
6.1 PENGISYTIHARAN PEMOHON (DIISI OLEH PEMOHON) / APPLICANT DECLARATION (TO BE FILED BY APPLICANT)

***TO BE FILED BY APPLICANT (INDIVIDUAL)**

I, [Name],
[Mykad No./ Passport No.

.....
of[Address].....
..... hereby -

- i. *appoint and authorize [Name of the Competent Person]..... [MyKad No./Pasport No.] as a Competent Person for this Application; confirm that the Competent Person appointed for this Application is a Competent Person according to section 2 of the Electricity Supply Act 1990 [Act 447];*
- ii. *confirm that I have not committed any offences under the Electricity Supply Act 1990 [Act 447] and/or any other relevant laws and regulations pertaining to the supply and licensing of electricity;*
- iv. *declare that I have never participated in any existing mechanism or program relating to solar photovoltaic installation*
- v. *certify that all information given is true and correct to my knowledge and belief;*
- vi. *understand and agree that, SEDA Malaysia shall cancel the approval of the application and forfeit any application fees paid if the solar PV installation is not commence to install within three (3) months from the date of the notification of the approval;*
- vii. *understand and agree that, SEDA Malaysia shall forfeit any application fees paid if I withdraw the application;*
- viii. *understand and agree that SEDA Malaysia shall have the right to take any action if any of the information given is false;*
- ix. *agree that SEDA Malaysia shall not be held liable for any loss, damage and inconvenience suffered by me after my application has been approved by SEDA Malaysia;*
- x. *agree, understand and will comply with all the relevant laws and guidelines applicable to this application.*

.....
Name:
Mykad No. / Passport No. :
Date:

***TO BE FILED BY APPLICANT (NON- INDIVIDUAL) (if applicable)**

I, [Name], [Mykad No./ Passport No.]
..... a [Designation]..... of a [Name of the Company/Ministry/
Department/Statutory Body/State Government/Local Authorities]
..... and [Address]
.....
.....
.....

- i. appoint and authorize [Name of the Competent Person]..... [MyKad No./Pasport No.] as a Competent Person for this Application;
- ii. confirm that the Competent Person appointed for this Application is a Competent Person according to section 2 of the Electricity Supply Act 1990 [Act 447];
- iii. confirm that I have not committed any offences under the Electricity Supply Act 1990 [Act 447] and/or any other relevant laws and regulations pertaining to the supply and licensing of electricity;
- iv. declare that I have never participated in any existing mechanism or program relating to solar photovoltaic installation
- v. certify that all information given is true and correct to my knowledge and belief;

- vi. understand and agree that, SEDA Malaysia shall cancel the approval of the application and forfeit any application fees paid if the solar PV installation is not commence to install within three (3) months from the date of the notification of the approval;
- vii. understand and agree that, SEDA Malaysia shall forfeit any application fees paid if I withdraw the application;
- viii. understand and agree that SEDA Malaysia shall have the right to take any action if any of the information given is false;
- ix. agree that SEDA Malaysia shall not be held liable for any loss, damage and inconvenience suffered by me after my application has been approved by SEDA Malaysia; and

- x. agree, understand and will comply with all the relevant laws and guidelines applicable to this application.

.....
Name of the Authorized
Representative:
Designation:
Mykad No. / Passport No. :
Date:

6.2 PENGISYTIHARAN KONTRAKTOR ELEKTRIK / ELECTRICAL CONTRACTOR DECLARATION

Untuk diisi oleh Orang Yang Kompeten / To be completed by Competent Person.

Company's Name:

Company Registration No. or Business Registration No. :

By signing this form, I (Name)..... (MyKad No. /Passport No.) declare that:

- i. I am representing the owner of the premise and the information furnished above is true to my knowledge and belief;
- ii. I confirm that the solar PV system design comply to the standards IEEE 1547, MS 1837 and other relevant requirements as per prudent utility practices;
- iii. I also verify that the site condition is fit for installation of the solar PV system as per applicable regulations;
- iv. I hereby acknowledge that all information given are true and the SEDA Malaysia shall have the right to take any action if the above information are false;

.....

Name of Competent Person:

MyKad No./Passport No.:

Date:

Signature & Stamp Competent Person :

**NET ENERGY METERING (NEM) GOMEN
APPLICATION FORM**

BORANG PERMOHONAN PEMETERAN TENAGA BERSIH (NEM) GOMEN

NET ENERGY METERING (NEM) GOMEN APPLICATION FORM



Sila kemukakan borang permohonan anda ke /
Please submit your application form to:
 Sustainable Energy Development Authority Malaysia
 Galeria PjH, Aras 9, Jalan P4W
 Persiaran Perdana, Presint 4,
 62100 Putrajaya, MALAYSIA

Untuk kegunaan pejabat sahaja /
For office use only:
 Reference No. :
 Serial No. :
 Date Received :/...../.....
 Time received :
 Receiving Officer :

BAHAGIAN 1 : MAKLUMAT PEMOHON / SECTION 1 : APPLICANT INFORMATION (BORANG INI HENDAKLAH DIISI DENGAN HURUF BESAR) / (THIS FORM TO BE COMPLETED IN CAPITAL LETTERS):

BUTIRAN PEMOHON / APPLICANT DETAIL

Nama Organisasi/ Kementerian/ Entiti Kerajaan/ PBT/ Name of Organization / Ministry/ Government Entity/ Local Authority:

No. Pendaftaran atau Pertubuhan Organisasi/ Badan Kerajaan (jika berkenaan)/ Registration no. for Organization/
 Government body (if applicable) or e-PBT No. (untuk PBT / for local authority):

Tarikh ditubuhkan / Date of incorporation : - -

Alamat Berdaftar / Registered Address :

Poskod / Post Code Bandar / Town Negeri / State

Alamat Perniagaan/ Surat-Menyurat (jika berlainan) / Business/ Mailing Address (if different):

Poskod / Post Code Bandar / Town Negeri / State

No. Tel (P) / Tel (O) No. - No. Faks (P) / Fax No. (O) -

E-mel / E-mail Laman Web / Website

ORANG YANG BOLEH DIHUBUNGI / CONTACT PERSON

Gelaran/Salutation (Encik/Puan/Cik/Gelaran Lain _____) No. Mykad: - -
 (Mr./Mrs./Miss/Other Salutation) Identity Card No. atau / or

Nama / Name No. Pasport (bagi bukan warganegara Malaysia) /
 Passport No. (For non-Malaysian)

Jawatan / Position: No. Tel / Tel. No.:

Kewarganegaraan / Citizenship No. Tel. Bimbit / Mobile No.:
 E-mel / E-mail:

BAHAGIAN 2 : MAKLUMAT PROJEK / SECTION 2 : PROJECT INFORMATION

2.1. ALAMAT PEPASANGAN/ INSTALLATION ADDRESS

Alamat Tapak Pemasangan / Site Installation address

Poskod / Post Code Bandar / Town Negeri / State

Pemilikan Tapak / Site Ownership : Dimiliki Sepenuhnya / Sendiri (Pajakan kepada bank) / Sewa/ Leased
 Fully Owned Owned (Charged to bank)

Lokasi GPS Tapak Pemasangan / GPS Location of Site Installation:
 Latitud / Latitude : ° ' " Longitud / Longitude : ° ' "

2.2 MAKLUMAT PEPASANGAN / INFORMATION OF INSTALLATIONNama Pemegang Lesen Pengagihan / *Distribution Licensee*:Kategori Tarif / *Tariff Category* :

Tariff TNB

Maklumat Bil (No. Akaun) / *Billing Information (Account No.)* :No. Kontrak/ *Contract No.* :Sumber Tenaga Boleh Baharu / *Renewable Energy Resources*:Kapasiti Terpasang Yang Diisytiharkan / *Declared Installed Capacity* :Kapasiti Terpasang / *Installed Capacity* :

Adakah pemohon pernah menyertai mana-mana program fotovolt suria sebelum ini? Jika **Ya**, sila nyatakan maklumat yang diperlukan di bawah/ *Have the applicant participated in any of the prior solar PV programmes? if Yes, please the required information below:*

TENAGA NASIONAL BERHAD (TNB)											
Perniagaan/ Commercial											
SOLAR PV											

 kWac kWp

No.	Program/ Mekanisme Programme/ Mechanism	Kapasiti Terpasang Installed Capacity	Alamat pemasangan/ Installation address

2.3 MAKLUMAT PEMBEKALAN DAN PEPASANGAN / SUPPLY AND INSTALLATION INFORMATION

Tahap Voltan Pada Titik Sambungan Meter TNB

/ Voltage level at TNB Meter Connection Point:

 Voltan Rendah (*Satu Fasa*) Low Voltage (*Three Phase*) Voltan Sederhana / *Medium Voltage*Voltan pada Titik Gandungan Sepunya / *Voltage at Point of Common Coupling* : Voltan / *Voltage*Voltan Rendah / *Low Voltage (LV)* : i) Arus Keseluruhan / *whole current* <=100A, Kadar Fius / *Fuse Rating* atau/or ii) Kadar CT LV / *LV CT Rating* Voltan Sederhana / *Medium Voltage (MV)* : Kadar CT MV/ *MV CT Rating* Status Projek/*Project Status*: Projek Baru/*New Project* Projek Telah Siap/*Completed Project* Penambahan kapasitiJenis Bangunan / *Types of Building*:/ *increase capacity*Contoh: Pejabat/ Dewan Serbaguna/ Lain-lain / *Example: Office/ Multipurpose Hall/ Others*Penggunaan Bateri Simpanan / *Use of Battery Storage* : Ya / *Yes* Tidak / *No**Jika **Ya**, sila kemukakan reka bentuk terperinci / *If Yes, please provide detail design.*Kapasiti Bateri / *Battery Capacity* :Jenama dan Model / *Brand and Model*:Anggaran Penjanaan Tenaga Tahunan / *Estimated Annual Energy Generation*: MWh/yearAnggaran Kerosotan Pemasangan / *Expected Plant Deterioration*: %/year**2.4 MAKLUMAT TEKNIKAL / TECHNICAL INFORMATION:**

Peralatan / <i>Equipments</i>	Jenama / <i>Brand</i>	Model	Kuantiti / <i>Quantity</i>
a) Modul/ <i>Module</i> jenis / <i>type</i> (<i>monocrystalline/ polycrystalline/ thin film/others</i>)			
b) Penyongsang pintar / <i>Smart Inverter</i>			
c) Datalogger (Optional) *For capacity more than 72kWac will be required for T&C purpose			

2.5 PEMBEKAL PERKHIDMATAN SURIA FOTOVOLTA BERDAFTAR SEDA MALAYSIA / SEDA MALAYSIA REGISTERED PV SERVICE PROVIDER (RPVSP)

Nama Syarikat / Company's Name:

No. Pendaftaran Syarikat / No. Perniagaan:

Company Registration No. / Business Registration No.

Syarikat RPVSP berdaftar SEDA M'sia / SEDA M'sia's RPVSP company Ya / Yes Tidak / No

Jika Ya, No. Sijil Pendaftaran / If yes, Certificate Registration No.

Kontraktor Elektrik Berdaftar ST / ST's Registered Electrical Contractor Ya / Yes Tidak / No

Jika Ya, No. Sijil Pendaftaran / If yes, Certificate Registration No.

Alamat Pejabat / Office Address :

Poskod / Post Code Bandar / Town Negeri / State

No. Telefon/Telephone No. - No. Faks / Fax No. -

E-mel Syarikat / Company E-mail :

Orang Yang Boleh Dihubungi / Contact Person :

Jawatan / Position :

No. Tel. Bimbit / Mobile No. : -

E-mel / E-mail:

2.6 PENDAWAI (≤72kWac) ATAU JURUTERA PROFESSIONAL (>72kWac) / WIREMAN (≤72kWac) OR PROFESSIONAL ENGINEER (>72kWac)

Nama / Name No. Mykad: - -

Identity Card No.

Nama Syarikat No. Tel. Bimbit / Mobile No:

E-mel

/ E-mail

No. Sijil Pendaftaran ST / ST's Certificate Registration No.

BAHAGIAN 3 : MAKLUMAT PEMBIAYAAN / SECTION 3 : FINANCING INFORMATION

Capital Expenditure

1 Equipment Cost:

i.	PV module	RM
ii.	PV Inverter	RM
iii.	Balance of system	RM
iv.	Other Equipment cost (please state):	RM
Total Equipment Cost		RM

2 Installation Cost

i.	Consultancy and Design Cost	RM
ii.	Interconnection Cost	RM
iii.	Preliminary Cost	RM
iv.	Other Installation Cost (please state):	RM
Total Installation Cost		RM

3 Annual Operational Expenditure

i.	Insurance Premium	RM
ii.	Operation and Maintenance Cost	RM
iii.	Other operation Cost (Please state):	RM
Total Operating Cost		RM

Financial Model, please tick (/) whichever applicable:

- a. Outright/Direct Purchase
- b. Bank Loan
- c. Solar Leasing/Hire Purchase
- d. Solar Power Purchase Agreement (PPA)
- e. Hybrid of Solar Leasing and Solar PPA

For "Solar Leasing/Hire Purchase or Solar Power Purchase Agreement (PPA) or Hybrid of Solar Leasing and Solar PPA" system, please provide the information below:

- i. Registered Solar PV Investor:
- Contract Period: Year
- Repayment Method: i. Repayment Amount (RM/kWh)
- ii. Repayment Amount (RM/month)

BAHAGIAN 4 : JADUAL KERJA YANG DICADANGKAN / SECTION 4 : PROPOSED WORK PLAN

No.	Pencapaian / Milestones	Anggaran Tarikh Akhir / Estimated Due date
1	Tarikh Permohonan NEM dikemukakan / <i>NEM application submission date</i>	
2	Cadangan tarikh permulaan bagi kerja-kerja pemasangan sistem fotovolta suria (dalam tempoh 3 bulan dari tarikh kelulusan NEM)/ <i>Proposed date for commencement of solar PV system installation work (within 3 months from the date of NEM approval</i>	
3	Permohonan Lesen Penjanaan daripada Suruhanjaya Tenaga (ST) / Application Generating Licence from Suruhanjaya Tenaga (ST) *Bagi permohonan berkapasiti melebihi 24kW (satu fasa) atau melebihi 72kW (tiga fasa) sahaja / For application with capacity more than 24kW (single phase) or more than 72kW (three phase)	
4	Tarikh cadangan T&C bersama Pemegang Lesen Pengagihan bagi penukaran/menaiktaraf meter utiliti [jika perlu] / <i>T&C Proposal Date with Distribution Licensee for Changing/Upgrade Utility Meter [if</i>	
5	Tarikh Pentauliahahan NEM (Cadangan tarikh menandatangani kontrak NEM) / <i>NEM Commencement Date (Proposed date for signing of NEM contract)</i>	

BAHAGIAN 5 : SENARAI SEMAK DOKUMEN SOKONGAN / SECTION 5 : SUPPORTING DOCUMENTS CHECKLIST

Salinan bagi dokumen-dokumen berikut hendaklah dikemukakan bagi menyokong permohonan ini, yang mana berkenaan /
The following documents are to be submitted in support of this application, where applicable:

No.	Dokumen Yang Diperlukan / Documents Required	Sila [/] / Please [/]
1.0	Applicant Information: i) Organisation (Body Corporate): The certificate from the appropriate authority certifying that the body has been duly constituted under the said written law; ii) Organisation (Society): The certificate of registration issued by the Malaysia Co-operative Societies Commission; iii) Organisation (Firm): The certificate of registration (Form D) of the firm issued by the Registrar of Businesses; or the letter or certificate relating to the constitution of the firm from bodies regulating the profession in which the firm is practising in; iv) Organisation (Registered Society): The certificate of registration issued by the Malaysia Co-operative Societies Commission; v) Organisation (Care Centre): The certificate of registration of the care centre issued by the Social Welfare Department of Malaysia or the relevant religious authority; vi) Organisation (Place of Worship): The certificate of registration of the place of worship issued by the relevant religious authority; or the certificate of registration of the society in charge of the place of worship issued by the Registrar of Societies and a letter from the relevant local authority confirming that the place of worship has duly obtained a certificate of completion and compliance or certificate of fitness or other applicable approval; or vii) Organisation (Educational Institution): The certificate of registration of the educational institution issued by the Ministry of Education; or in the case of religious schools, the certificate of registration of the religious school issued by the relevant religious authority. vii) Ministry/ government entities: Supporting documents with regards to the establishment of Government Agency	
2.0	Site Information: 2.1 Documents proving the Applicant's ownership of the site, or other conditional or unconditional rights (e.g. letter or agreement) that the Applicant has to utilise/lease the site for a minimum period equivalent to the effective period	
3.0	Technical Information: 3.1 i) Installation less than 72kWac: The detailed engineering design of the renewable energy installation, including all relevant calculations to justify the installed capacity and claimed efficiencies, proposed plant layout and AC/DC single line diagram certified by relevant Competent Person under Electricity Supply Act 1990 and the regulations thereunder; and SEDA Malaysia Qualified Person (SEDA Malaysia GCPV System Design Certificate Holder); OR ii) Installation exceeding 72kWac: The detailed engineering design of the renewable energy installation, including all relevant calculations to justify the installed capacity and claimed efficiencies, proposed plant layout and AC/DC single line diagram certified by relevant Competent Person under Electricity Supply Act 1990 and the regulations thereunder; and SEDA Malaysia Qualified Person (SEDA Malaysia GCPV System Design Certificate Holder). 3.2 Installation exceeding 72kWac: Report on the Net Energy Metering Assessment Study; Conducted in accordance with the Renewable Energy (Technical and Operational Requirements) Rules 2011 3.3 Product data sheet / technical parameter for all electrical components. Please provide rating of each electrical components (SPD, fuses, switches, PV modules, Inverters) 3.4 If use battery storage, please provide detail design;	
4.0	Billing information: i) Documentary evidence showing that applicant has applied to be a consumer of TNB or a copy of three (3) months electricity bill (latest);	

5.0	<i>Competency Certificates:</i>	
5.1	Competent Person certificates:	
	i) A certificate of registration as an Electrical Contractor issued by ST;	
	ii) A certificate of registration as a Professional Engineer (Electrical) with Board of Engineers Malaysia for each Competent Person's;	
	iii) A certificate(s) of Competency as a Wireman issued by the ST for each Competent Person's	
5.2	SEDA Malaysia Qualified Person certificates:	
	i) A certificate of Competency in GCPV System Design issued by SEDA Malaysia for each Competent Person's	
	ii) A certificate of Competency as a Wiremen in GCPV System issued by SEDA Malaysia for each Competent Person's	
6.0	<i>Others (Please specify):</i>	
	<i>i)</i>	
	<i>ii)</i>	
	<i>iii)</i>	

BAHAGIAN 6 : PENGISYTIHARAN BAGI PERMOHONAN NEM / SECTION 6 : DECLARATION FOR NEM APPLICATION

6.1 PENGISYTIHARAN PEMOHON (DIISI OLEH PEMOHON) / APPLICANT DECLARATION (TO BE FILED BY APPLICANT)

I, [Name], [Mykad No./
Passport No.] a
[Designation]..... of a [Name of the Company/ Ministry/ Department/
Statutory Body/ State Government/ Local Authorities]

..... and
[Address]

..... an authorized representative of this Applicant hereby-

- i. appoint and authorize [name of the Competent Person].....[MyKad No./Pasport No]. as a Competent Person for this Application;
- ii. confirm that the Competent Person appointed for this Application is a Competent Person according to section 2 of the Electricity Supply Act 1990 [Act 447];
- iii. confirm that I have not committed any offences under the Electricity Supply Act 1990 [Act 447] and/or any other relevant laws and regulations pertaining to the supply and licensing of electricity;
- iv. declare that I have never participated in any existing mechanism or program relating to solar photovoltaic installation including Feed-in Tariff (FiT), Net Energy Metering 2.0 (NEM 2.0), SELCO, LSS and etc.;
- v. certify that all information given is true and correct to my knowledge and belief;
- vi. understand and agree that, SEDA Malaysia shall cancel the approval of the application and forfeit any application fees paid if the solar PV installation is not commence to install within three (3) months from the date of the notification of the approval;
- vii. understand and agree that, SEDA Malaysia shall forfeit any application fees paid if I withdraw the application;
- viii. understand and agree that SEDA Malaysia shall have the right to take any action if any of the information given is false;
- ix. agree that SEDA Malaysia shall not be held liable for any loss, damage and inconvenience suffered by me after my application has been approved by SEDA Malaysia; and
- x. agree, understand and will comply with all the relevant laws and guidelines applicable to this application.

.....
Name of the Authorized

Representative:

Designation:

Mykad No. / Passport No. :

Date:

6.2 PENGISYTIHARAN KONTRAKTOR ELEKTRIK / ELECTRICAL CONTRACTOR DECLARATION

Untuk diisi oleh Orang Yang Kompeten / To be completed by Competent Person.

Company's Name:

Company Registration No. or Business Registration No. :

By signing this form, I (Name)..... (MyKad No

, /Passport No.) declare that:

- i. I am representing the owner of the premise and the information furnished above is true to my knowledge and belief;
- ii. I confirm that the solar PV system design comply to the standards IEEE 1547, MS 1837 and other relevant requirements as per prudent utility practices;
- iii. I also verify that the site condition is fit for installation of the solar PV system as per applicable regulations;
- iv. I hereby acknowledge that all information given are true and the SEDA Malaysia shall have the right to take any action if the above information are false;

.....

Name of Competent Person:

MyKad No./Passport No.:

Date:

Signature & Stamp Competent Person :

SCHEDULE 3

**NET ENERGY METERING (NEM) CONTRACT
FOR
NEM RAKYAT**

NET METERING (NEM) CONTRACT FOR NEM RAKYAT

DEFINITIONS

- (a) **ACT**
means the Electricity Supply Act 1990 (Act 447) and/or any regulations made thereunder and/or any amendment, revision, modification or enactment made thereto or thereof from time to time for the time being in force.
- (b) **BILLING CYCLE PERIOD**
means (i) the period beginning on the Commissioning Date and ending on the last day of the calendar year in which the Commissioning Date occurs; and (ii) each twelve (12) months' period thereafter during the term of this Contract, or such other period as may be approved by the Government of Malaysia from time to time.
- (c) **BILLING MONTH**
means the period between two (2) successive meter readings. The Net Meter is normally read at intervals of approximately thirty (30) days.
- (d) **CHANGE OF TENANCY**
means a change of the registered consumer who is responsible to make payment of electricity bill of an existing TNB's account.
- (e) **COMMISSIONING DATE**
means the date on which the Net Meter is commissioned as notified by TNB.
- (f) **COMPETENT PERSON**
means a person who holds a Certificate of Registration as an Electrical Contractor issued under the Electricity Regulations 1994.
- (g) **CONSUMER**
means any domestic consumer who:
(i) is an individual of a Malaysian nationality or a foreign nationality having residential address in Malaysia;
(ii) is a registered consumer of TNB who has entered into the Electricity Supply Contract;
(iii) is or will be supplied with electricity whereby the Premises are at the material time is connected or will be connected; and
(iv) is operating the Renewable Energy System on the rooftop of the Premises.
- (h) **CONTRACT**
means the contract comprising of terms and conditions hereunder and NEM application form.
- (i) **ELECTRICITY SUPPLY CONTRACT**
means the existing electricity supply contract entered into between the Consumer and TNB for the supply of electricity in accordance with the Act.
- (j) **EXPORT ENERGY**
means the renewable energy generated and delivered by the Renewable Energy System to TNB's system, as measured in kWh by the Net Meter.

- (k) **GENERATED AMOUNT**
means an amount (in RM) equal to the Export Energy multiplied by the Tariff.
- (l) **IMPORT ENERGY**
means the electricity supplied by TNB and consumed by the Consumer, as measured in kWh by the Net Meter.
- (m) **kW**
means kilowatt.
- (n) **kWh**
means kilowatt-hour.
- (o) **METER INSTALLATION CHARGES**
means an upfront contribution amount payable by a Consumer requiring infrastructure for new supply and/or upgrading of existing infrastructure for additional supply requirement and for the purpose of this Contract, the installation and connection of Net Meter, as approved by the Suruhanjaya Tenaga or any relevant authority.
- (p) **NEM MONTHLY MINIMUM CHARGE (NMMC)**
means a monthly charge applicable to the Consumer in the event its monthly total charge for the difference between the Import Energy and the Export Energy is less than the stated amount stipulated in the prevailing Tariff as approved by the Government of Malaysia.
- (q) **NET METER**
means the metering equipment and devices supplied and installed by TNB for the measurement of the Import Energy and the Export Energy.
- (r) **PREMISES**
means the residential dwelling unit of the Consumer on which the Renewable Energy System is installed.
- (s) **RENEWABLE ENERGY METER**
means the renewable energy meter to be procured and installed at the Premises for the purpose of capturing the gross renewable energy generated from the Renewable Energy System.
- (t) **RENEWABLE ENERGY SYSTEM**
means the renewable energy system located on the rooftop of the Premises which fully complies with the Technical Guidelines and the guidelines as may be issued by the Suruhanjaya Tenaga, grid-connected inverter, the associated protection and control devices, alternating current and direct current cables and other related devices up to the Consumer's termination point.
- (u) **SUPPLIED AMOUNT**
means an amount (in RM) equal to the Import Energy multiplied by the Tariff.

- (v) **SURUHANJAYA TENAGA**
means the Suruhanjaya Tenaga established under the Energy Commission Act 2001 and any successor thereof.
- (w) **TARIFF**
means the prevailing tariff, as provided by the Act and approved by the Government of Malaysia.
- (x) **TECHNICAL GUIDELINES**
means TNB's technical guidelines as may be amended, revised, modified or supplemented from time to time, which provide the minimum technical, operation and safety requirements in ensuring that the features of the Renewable Energy System and the Net Meter are compatible with TNB's requirements.
- (y) **TNB**
means Tenaga Nasional Berhad (200866-W), a company incorporated in Malaysia under the Companies Act 1965 and having its registered address at Pejabat Setiausaha Syarikat, Tingkat 2, Ibu Pejabat Tenaga Nasional Berhad, No. 129, Jalan Bangsar, 59200 Kuala Lumpur and having branches in Peninsular Malaysia.

A. TERM OF CONTRACT

This Contract shall be effective on the Commissioning Date and shall remain in effect for a term of ten (10) years which expires on the last day of the month in which the tenth (10th) anniversary of the Commissioning Date occurs, unless otherwise terminated in accordance with the provisions of this Contract.

Upon the expiry of the term of this Contract, the Consumer agrees with TNB that the Consumer shall be registered by TNB as self-consumption and subject to the guidelines relating to self-consumption as issued by the Suruhanjaya Tenaga.

B. CONSUMER'S COVENANTS

1. CONSUMER DECLARATION

The Consumer shall abide at all times to the Consumer Declaration as stipulated in the NEM application form and the following terms:

- (a) To ensure that the Renewable Energy System complies with the Technical Guidelines, all prevailing statutory requirements and best practices on safety, reliability and power quality of electrical installation as stipulated in the Malaysian Distribution Code and any amendments made thereunder.
- (b) The Renewable Energy System shall incorporate an anti-islanding function to ensure that the Renewable Energy System automatically disconnect from TNB's system during power interruption to allow TNB's personnel to work safely on the TNB's system.
- (c) Any other obligations under the Act.

2. REPRESENTATIONS AND WARRANTIES OF THE CONSUMER

The Consumer represents and warrants to TNB that:

- (a) The Consumer is an individual domicile and having a residential address in Malaysia.

- (b) The Consumer has full control and possession of the Premises, including all necessary ownership rights, leases, tenancies, title and/or interest of the Premises.
- (c) The Consumer shall comply with the provisions of all statutes, ordinances, by-laws, regulations and rules for the time being in force affecting the Premises or any constructions, improvements, installations, additions or alterations thereon and forthwith to satisfy all requirements of the municipality or any other local authority with respect to the Premises.
- (d) If the Consumer is a tenant of the Premises, the Consumer shall have obtained the prior written consent of the owner of the Premises for the installation and commissioning of the Net Meter.
- (e) The Consumer is not bankrupt and/or subject to any pending action or proceeding affecting the Consumer before any court, government entity or arbitrator that is likely to affect materially and adversely the financial condition or operations of the Consumer and the ability of the Consumer to perform its obligations hereunder, or that purports to affect the legality, validity or enforceability of this Contract.
- (f) The Consumer shall remain a Consumer of record of TNB for its own electricity consumption in good standing at all times, and shall not cause the Renewable Energy System, the Renewable Energy Meter and the Net Meter to be disconnected or removed from the Premises without the prior written consent of TNB.
- (g) The capacity of the Renewable Energy System shall not exceed:
 - (i) 4kW for single phase wiring system; and
 - (ii) 10kW for three phase wiring system.
- (h) The specifications of the Renewable Energy System shall be as set in the NEM application form.
- (i) The Consumer shall have procured the installation of the necessary GPRS broadband signal at the Premises which is required for the remote reading of the Net Meter.
- (j) The Consumer shall comply with the terms and conditions under this Contract and the provisions under the Act.
- (k) The Consumer shall not install and operate virtual net meter which enables the Consumer to allocate the net excess in kWh generated by the Renewable Energy System to other resident within the vicinity of the Premises.
- (l) The Consumer shall immediately notify TNB of any change in the Consumer's personal information as provided for the purpose of this Contract.
- (m) The Consumer undertakes to operate and maintain the Renewable Energy System in accordance with the Technical Guidelines and the guidelines as may be issued by the Suruhanjaya Tenaga.
- (n) The Consumer shall immediately notify the Sustainable Energy Development Authority of any change in the Consumer's tariff classification.
- (o) This Contract constitutes a legal, valid and binding obligation of the Consumer.

3. METER INSTALLATION CHARGE

To pay to TNB a Meter Installation Charge in full (if any) and such payment to be paid before any work of installation and connection of the Net Meter is commenced by TNB, as provided in the Act.

4. DISCONNECTION FEE

In the event the Renewable Energy System is disconnected from TNB's system and/or electricity supply is disconnected from the Premises, then appropriate fees shall be charged for such disconnection.

5. ACCESS

The Consumer consents with TNB that the authorised employees, servants, agents and/or representatives of TNB shall be permitted to have access to the Premises at reasonable time, manner and circumstances:

- (a) To carry out their duties which include but not limited to the construction, installation, inspection, testing and/or reading of the Net Meter, the Renewable Energy Meter and/or the Renewable Energy System or other relevant things relevant to the supply of electricity to the Premises.
- (b) To disconnect the Renewable Energy System from TNB's system and/or the supply of electricity to the Premises upon the occurrence of any of the circumstances as set out in Clause 22.
- (c) For entry pursuant to Clause 5(a), TNB shall make good any damage, if any, as a result of such entry.

6. COSTS AND EXPENSES FOR RENEWABLE ENERGY SYSTEM, NET METER AND RENEWABLE ENERGY METER

All costs and expenses relating to the procurement, installation, testing, energizing and commissioning of the Renewable Energy System, the Net Meter and the Renewable Energy Meter together with the replacement or any future modification or relocation of the Renewable Energy System, the Net Meter and the Renewable Energy Meter shall solely be borne by the Consumer.

7. NO INTERFERENCE OF ELECTRICITY SUPPLY TO OTHER CONSUMERS

- (a) To operate and maintain the Renewable Energy System and/or use electricity supply so as not to interfere with the supply of electricity to any other consumers or TNB's electrical installation.
- (b) In the occurrence of the circumstances in Clause 7(a), the Consumer shall make good any loss or damage to TNB and/or made payment for the amount in the reasonable opinion of TNB to be the costs making good for such loss or damage.

8. NO OBSTRUCTION TO TNB'S INSTALLATION

- (a) The Consumer shall not create any obstruction and/or undertake any activity in the vicinity of any TNB's electrical installation and/or place any equipment which may endanger life or properties and/or to make any electrical wiring and/or installation to the existing installation without any written permission from the Suruhanjaya Tenaga and/or TNB.
- (b)
 - (i) TNB has the right to take any reasonable actions to remove any obstruction created by the Consumer or representative under Consumer's supervision/control.
 - (ii) TNB shall not be liable to pay any compensation for any losses and/or damages to the Consumer due to the said removal.

9. RESPONSIBILITY TO MAKE GOOD ALL DAMAGES

The Consumer shall pay for all damages on TNB's installation within the Premises due to negligence on the Consumer's part or any persons under the Consumer's control.

10. TERMINATION BY THE CONSUMER

- (a) To give TNB a notice in writing and shall be served by:
 - (i) hand delivery; or
 - (ii) way of prepaid registered post; or
 - (iii) any applicable means which shall be determined by TNB.
- (b) Termination of this Contract shall be effective three (3) working days after TNB's receipt of termination notice.
- (c) Notwithstanding to the above, in the event the actual disconnection cannot be performed by TNB due to inevitable causes, the Consumer shall be liable to pay all charges relating to the electricity consumed until the actual disconnection.

11. TO TAKE SUPPLY OF ELECTRICITY

To take supply of electricity at the Premises according to the Tariff rates pursuant to the provision of the Act.

12. EXCEPTIONS TO ACCEPT THE EXPORT ENERGY

Notwithstanding any other provision in this Contract, TNB shall not be obligated to accept the Export Energy if any of the following circumstances occurs:

- (a) for such periods and under such circumstances as TNB thinks fit having regard to public safety and private safety;
- (b) any emergency condition occurs;
- (c) the Renewable Energy System delivers the Export Energy which does not conform to the electrical characteristics consistent with prudent utility practices;
- (d) TNB interrupts the acceptance of the Export Energy to conduct necessary maintenance of TNB's system or the Net Meter;
- (e) any constraint in TNB's system to which the Renewable Energy System relates;
- (f) any dishonest consumption of the electricity by the Consumer or any third person;
- (g) any of the force majeure event as set forth in Clause 24;
- (h) the disconnection of the Renewable Energy System from TNB's system due to the failure of the Consumer to pay the amount as stipulated under Clause 21; or
- (i) the Consumer is in non-compliance with its obligations under Clause 2.

13. UPKEEP AND MAINTENANCE OF TNB INSTALLATION

The Consumer agrees:

- (a) to take steps to ensure that no damage or tampering is caused to the said installation; and
- (b) to allow TNB to maintain any electrical installation within the Premises at any time for safety purposes.

If there is any defect or abnormality on the installation, TNB shall have the right to make good the defects without being liable for any damages provided always it is not due to the negligence or willful acts of TNB, its employees or agents.

14. VACATED PREMISES

- (a) If the Consumer vacates the Premises without giving any notice to TNB as provided under Clause 10, the Consumer shall be liable to pay all charges of electricity consumed and any charges payable relating to the electricity consumed until the installation is disconnected or upon the termination of this Contract, whichever is the later.
- (b) TNB shall have the right not to provide electricity supply to any other premises in which the account is registered under the Consumer's name until the Consumer has made the full payment of the outstanding balance.

15. NON-TRANSFERABLE AND NO SETTING OFF OF CREDIT AMOUNT

- (a) The Consumer shall not be entitled to transfer any credit amount as described in Clause 21(c) below to any other accounts of the Consumer or any third party account. For the avoidance of doubt, any remaining credit amount which may be subsisting at the end of each Billing Cycle Period or upon the termination of this Contract, as the case may be, shall be adjusted to zero without any compensation to the Consumer.
- (b) The Consumer shall not be entitled to set off any credit amount as described in Clause 21(c) below against any outstanding sums due and payable to TNB under the Electricity Supply Contract.

C. TNB'S COVENANTS

16. LOCATION OF TNB'S INSTALLATIONS

- (a) If any removal made to any TNB's installation and equipment which is likely to cause danger as provided under the Act, TNB shall have the right to disconnect electricity supply without notice.
- (b) If any relocation made to any TNB's installation and equipment without consent, TNB shall have the right to disconnect the electricity supply without notice and relocate the said installation and equipment with costs borne by the Consumer.

17. INSPECTION BY TNB

- (a) TNB may need to inspect and test all installations before connection of the Renewable Energy System or electricity supply. However, it is the responsibility of the Competent Person appointed by the Consumer to ensure that the installations are safe.
- (b) The Consumer shall inform TNB of any proposed extensions or alterations to the installations so that TNB may make inspection and test of the extension or alteration if TNB so desires.
- (c) TNB does not accept any responsibility for any loss or damage caused by or occurs during or after test due to any defect in the installation and any test carried out by TNB is for TNB's purposes only and does not imply any warranty that the installation is suitable for the Consumer's purposes or that it fully complies with the Technical Guidelines and the Act or any subsequent amendments made thereunder.

18. TEMPORARY DISCONNECTION

TNB may temporarily disconnect the supply of electricity to the Premises for any purposes in connection with TNB's efficient electricity supply system. TNB shall not be liable to provide any alternative supply to the Consumer after the disconnection.

19. USAGE OF INSTALLATION FOR OTHER CONSUMER

TNB may use its part of the installation to supply electricity to other consumers in the area.

D. MUTUAL COVENANTS

20. EQUIPMENTS AND INSTALLATIONS

Any installation comprising mains and service lines and other ancillary equipment up to and including the Net Meter will be the property of TNB.

21. BILLING AND PAYMENT

(a) TNB shall read the Net Meter on a monthly basis and shall measure the Import Energy and the Export Energy to determine the Supplied Amount and the Generated Amount respectively. The calculation of the Supplied Amount and the Generated Amount shall be based on the guidelines as may be issued by the Suruhanjaya Tenaga.

(b) If, during any relevant Billing Month, the Import Energy exceeds the Export Energy, then the Consumer shall be billed for an amount (in RM) equal to the difference between (i) the sum of Supplied Amount and the appropriate charges and taxes and (ii) the Generated Amount and the appropriate taxes. The bills rendered by TNB to the Consumer shall be paid by the Consumer within the stipulated period.

(c) If, during any relevant Billing Month, the Export Energy exceeds the Import Energy, then the Consumer shall be credited for an amount (in kWh) equal to such difference in the following Billing Month. Notwithstanding the above, the Consumer shall pay any appropriate taxes and charges (if any).

(d) At the end of each Billing Cycle Period or upon the termination of this Contract, as the case may be:

(i) any remaining amount as described in Clause 21(b) above shall be billed and paid by the Consumer in accordance with Clause 21(b); and

(ii) any credit amount as described in Clause 21(c) above which may be subsisting at the end of such Billing Cycle Period or upon the termination of this Contract shall be adjusted to zero without any compensation to the Consumer.

For the avoidance of doubt, if this Contract is terminated prior to the end of a Billing Cycle Period, any credit amount as described in Clause 21(c) above which may be subsisting shall be adjusted to zero without any compensation to the Consumer.

(e) In addition to the total payable amount as stated in any monthly bill for any Billing Month as described under Clause 21(b) and Clause 21(c), the Consumer may be imposed with a grid fixed charge and the appropriate taxes as provided in this Contract, if any.

(f) Notwithstanding anything hereinbefore mentioned, TNB shall have the right to impose the NEM Monthly Minimum Charge in the event the monthly total

charge for the difference between the Import Energy and the Export Energy is less than the stipulated amount in the Tariff Book.

- (g) TNB shall have the right to impose or levy a surcharge at the rate as prescribed under the Act on the outstanding amount, calculated until the date of full payment.
- (h) The Consumer shall be liable for electricity bills issued by TNB including any unpaid amount insofar as the account is registered under the Consumer's name regardless of any consumption of electricity by any third party.
- (i) The Consumer shall be responsible to repay the amount in the bills rendered by TNB including any other relevant charges for any invalid payment made by the Consumer such as false credit card, bounced cheque and any other invalid payment.
- (j) In the event the Consumer fails to make payments as required under this Clause 21, TNB shall have the right to disconnect the Renewable Energy System from TNB's system and/or the supply of electricity to the Premises or any other premises which is registered under the Consumer's name.
- (k) The Consumer shall be liable for any arrears of electricity bill and/or loss suffered by TNB by reason of dishonest consumption of electricity supply in all circumstances in accordance with the provisions of the Act.
- (l) TNB shall have the right to make adjustment and update of Consumer's account whenever necessary.
- (m) TNB shall be entitled to set off any amount due to it under this Contract against any sums due and payable to the Consumer under the terms of this Contract.

22. DISCONNECTION OF SUPPLY

- (a) Subject to the Act, TNB shall have the right to disconnect the Renewable Energy System from TNB's system and/or the supply of electricity to the Premises without giving prior notice in any situations mentioned below:
 - (i) any default by the Consumer under Clause 23 and such default are not remedied within the stipulated period if any;
 - (ii) by Court Order/Judgment;
 - (iii) if in the opinion of TNB that the continuation of the delivery of renewable energy by the Renewable Energy System to TNB's system or the supply of electricity to the Premises will jeopardize the safety, reliability or security of TNB's system or presents an imminent physical threat or endanger the safety, life or health of any person or property;
 - (iv) upon the receipt of the termination notice indicating the intention to terminate this Contract by either TNB or the Consumer;
 - (v) any removal made to any TNB's installation and equipment as described in Clause 16(a);
 - (vi) the occurrence of the circumstances as described in Clause 12(d) or Clause 12(e); or
 - (vii) any right to disconnect the Renewable Energy System from TNB's system and/or the supply of electricity to the Premises without notice as provided under the Act.
- (b) For the avoidance of doubt, the Consumer hereby irrevocably and unconditionally agrees and acknowledges that:
 - (i) TNB shall be excused from all its obligations under this Contract in the event TNB exercises its rights to disconnect the Renewable

- Energy System from TNB's system and/or the supply of electricity to the Premises in any situations as set out in this Clause 22; and
- (ii) TNB shall not be responsible for any loss or damage that may arise as a result of the disconnection of the Renewable Energy System from TNB's system and/or the supply of electricity to the Premises.

23. EVENT OF DEFAULT

The occurrence of any of the following shall constitute an event of default under this Contract and it is not limited to:

- (a) Act or default of the Consumer affecting the efficiency and/or safety of TNB's installation.
- (b) The Consumer has failed to comply and/or breach with any provision of this Contract and/or the Act and/or commit any offence under the Act.
- (c) The Consumer has obtained consent for the appointment of or the taking of possession by a receiver or liquidator of itself or of all or a substantial part of its property.
- (d) The Consumer acknowledges in writing its inability to pay its debt as such debts become due.
- (e) The Consumer makes a general assignment or an arrangement or composition with or for the benefit of its creditor.
- (f) Instituting a case voluntarily or filing a petition against any party seeking to take advantage of any law relating to bankruptcy, insolvency, restructuring of its debts, winding up or composition.
- (g) The Consumer is under receivership or under special administration or liquidation.
- (h) The Consumer is declared a bankrupt by the Court.
- (i) Upon the Consumer's death.
- (j) Failure to pay the amount as stipulated under Clause 21 above.
- (k) Any warranty, representation or covenant made by the Consumer in this Contract is false or inaccurate in any material respect.
- (l) The occurrence of a Change of Tenancy.
- (m) Consumption of electricity in any dishonest manner.
- (n) The Consumer fails to comply with any of the provisions stipulated under Clause 1 of this Contract.
- (o) The Electricity Supply Contract is terminated for any reason whatsoever.
- (p) In the event the Consumer vacates the Premises pursuant to Clause 14(a).

24. FORCE MAJEURE

Neither party shall be liable to the other party for any breach of terms and conditions of this Contract due to any of this event which shall include but not limited to national emergency war, hostilities, riot, civil commotion, earthquake, flood, disposition or by compliance with any order of government, local or any other authorities.

25. INDEMNITY AND NO LIABILITY CLAIM

- (a) The Consumer agrees to indemnify and keep indemnified (indemnifying) TNB from and against all and/or any claims, actions, compensations, suits, proceedings, demands and all legal costs incurred thereby, brought against TNB, its servants or agents by a third party to which TNB shall or may be or become liable in respect of or arising from the performance of this Contract

provided always it is not due to the negligence or willful acts of TNB, its employees or agents.

- (b) The Consumer shall at all times be fully liable to TNB and remain responsible for all damages flowing from any breach or default of any term or obligation in this Contract regardless of whether the Renewable Energy System and the Renewable Energy Meter are installed and owned by a third party or otherwise.
- (c) The Consumer hereby agrees that neither TNB nor its employees, servants, agents, representatives shall be liable and/or make good the Consumer in respect of any damage, injury or loss to any of the Consumer's property and/or life arising from any fault of the TNB's system or the Consumer's installation at the Premises unless such damage, injury or loss have been proven as a result of any willful act, negligence, omission and/or failure to comply with any safety measures as provided under any written law.
- (d) The Consumer hereby agrees further that TNB shall not be liable for any cost incurred, loss and/or damage of industrial goods, product, property or life of the Consumer as a result of any unavoidable accident, voltage fluctuation, interruption, reduction and/or cessation of the electricity supply, fire or accident that may occur in consequence of the supply of electricity or the use or misuse which is not due to the negligence or willful act of TNB and/or its employees.

26. NOTICES

Unless and otherwise provided under the Act and any Clause stated under this Contract, any notice, demand or other communication which is required or allowed to be given or made under this Contract shall be in writing and shall be served by hand delivery or by way of prepaid registered post or ordinary post or any electronic means as mutually agreed by both parties to the address stated in this Contract. Proof of posting or service of any notice, demand or communication shall be deemed to be duly served:

- (a) if service is delivered by hand, at the time of such delivery and duly acknowledged;
- (b) if service is by way of post, on the third (3rd) working day after posting thereof; or
- (c) if service is delivered by electronic means, at the time of such delivery report.

Provided that the above Clause 26 shall not be applied to the termination of this Contract.

27. REMOVAL OF TNB INSTALLATION

If the Consumer or the proprietor of the Premises requests TNB to remove or relocate the supply line, pole, sub-station, pylon or any other TNB's installation or equipment within or outside the Premises, subject to consent by TNB, all costs of executing the removal or relocation shall be fully borne by the Consumer or the proprietor as the case may be.

28. SERVICES OF LEGAL PROCESS

The service of any legal process shall be by way of prepaid registered post sent to the address as stated in this Contract. Proof of posting shall be regarded as proof of acceptance and the said service shall be deemed to have been duly served and duly received upon the expiry of five (5) days from the date of posting.

29. TERMINATION OF CONTRACT BY TNB

- (a) TNB may terminate this Contract at any time upon giving not less than fourteen (14) working days' notice in writing of its intention to do so.
- (b) TNB may terminate this Contract under Clause 22(a) by giving fourteen (14) working days' notice from the date of expiry of the remedy period, except for the situations in Clause 22(a)(ii) and Clause 22(a)(iv).
- (c) If the Consumer renders to TNB a temporary notice of disconnection of the Renewable Energy System from TNB's system and/or the supply of electricity to the Premises thereby it shall be deemed as a notice of termination of the Contract and subject to the issuance of notice under Clause 29(a).
- (d) If TNB discovers that the information given is false and/or is disputed with the existence of prima facie proof relating to the delivery of renewable energy by the Renewable Energy System and the supply of electricity to the Premises and proven by any applicable laws or court order, TNB shall have the right to terminate this Contract upon giving a written notice of not less than twenty-four (24) hours.
- (e) If TNB for any reasons pursuant to any laws or under any direction of the Suruhanjaya Tenaga and/or relevant authority has been given the right to terminate this Contract.

30. CONSEQUENCES OF TERMINATION

On such effective date of termination under Clause 10 or Clause 29,

- (a) TNB shall be discharged from any obligations and liabilities under this Contract including any claim for damages without prejudice to TNB's rights to make such claim due to the disconnection of the Renewable Energy System from TNB's system and/or the supply of electricity to the Premises and the termination of this Contract;
- (b) the terms and conditions as specified in the Electricity Supply Contract shall then be applicable; and
- (c) this Clause 30 shall survive the termination of this Contract.

31. TRANSFER OF OUTSTANDING AMOUNT AND BALANCE OF DEPOSIT

- (a) TNB shall have the right to transfer any outstanding amount of electricity bills from any vacated account of the Consumer to any active account registered under the Consumer's name.
- (b) If there is a balance of deposit from the Consumer's vacated account, TNB shall have the right to use the balance of the deposit to adjust for any outstanding amount from whichever active account registered under the Consumer's name.

32. ENVIRONMENT ATTRIBUTE

The value of any credits or financial benefits which are available or may become available for reductions of "green house gas" emissions earned from the generation of renewable energy by the Renewable Energy System shall be solely for the benefit of the Consumer.

E. MISCELLANEOUS

33. AMENDMENT, MODIFICATION OR REPLACEMENT

TNB reserves the right to amend, modify, revise or replace the terms and conditions stipulated under this Contract from time to time. TNB may give notice of amendment to the Consumer in such a manner as TNB reasonably deems appropriate.

34. CHANGE IN NEM SCHEME AND/OR THE ACT

In the event of any change in the NEM scheme and/or the Act including but not limited to the application of the Technical Guidelines or the discontinuation of the NEM scheme as decided by the Government of Malaysia, TNB may by written notice to the Consumer unilaterally amend the terms and conditions of this Contract in any manner that it deems fit in order to ensure the compliance of the Government of Malaysia's decision, the Act and the Technical Guidelines.

35. ASSIGNMENT

The Consumer shall not assign any of the rights or obligations arising under this Contract to any third party without the prior consent in writing of TNB. TNB shall be entitled to assign or transfer its interest, rights and obligations in whole or in part under this Contract without the Consumer's prior written consent and the Consumer hereby agrees to execute such agreement and do such things as may be required by TNB to give effect to such assignment and/or transfer.

36. CONFIDENTIALITY

- (a) Except as it is or becomes a part of the public domain or as provided hereunder, all information provided by either party under this Contract shall be confidential at all times unless specified otherwise in writing.
- (b) The Consumer agrees that TNB may disclose all information provided by the Consumer under this Contract (including but not limited to any data or information from the reading of the meters), without limitation to the relevant departments and subsidiaries of TNB, including TNB's agents, advisors and outsource service providers, inside or outside of Malaysia, as well as the Suruhanjaya Tenaga, any other government entity and court or if required by any laws and regulations made thereunder.

37. GOVERNING LAW

This Contract shall be governed by and construed in accordance with the Act and any regulations made thereunder including any amendment thereto as well as any other relevant written laws.

38. INSTALLATION OF EQUIPMENT TO GENERATE RENEWABLE ENERGY

The Consumer shall inform TNB on any equipment installed at the Premises for the purpose of generating renewable energy.

39. PERSONAL DATA PROTECTION

- (a) TNB respect the privacy of all individuals with whom TNB has a contractual relationship. TNB is committed in protecting all personal data kept by TNB. For this reason, TNB has adopted its Personal Data Protection Policy which is in compliance with the Personal Data Protection Act 2010.

- (b) The Consumer has read and fully understands TNB's Personal Data Protection Policy which is available at <https://www.tnb.com.my/terms-policy/personal-data-protection-policy-pdpa/>.

40. SEVERABILITY

If any one or more of the provisions or part thereof contained in this Contract should be or become invalid or unenforceable due to whatsoever reasons this shall not in any way affect or impair the validity or enforceability of the remaining provision hereof.

41. STAMP DUTY

The stamp duty in respect of this Contract shall be borne and fully paid by the Consumer.

42. SUCCESSORS-IN-TITLE

This Contract shall be binding upon the successors-in-title and permitted assigns of the respective parties hereto.

43. TAXES

The Consumer shall be responsible for all present and future taxes, duties, levies and other similar charges including any related interest and penalties, however designated, arising out or in connection with the supply of any kind imposed by law.

44. TIME PERIOD

Time wherever mentioned shall be the essence of this Contract.

45. WAIVER

Knowledge or acquiescence by TNB of or in breach of any of the conditions or covenants herein contained shall not operate as or be deemed to be waiver of such conditions or covenants or any of them and notwithstanding such acknowledge or acquiescence, TNB shall be entitled to exercise its rights under this Contract.

46. APPLICABILITY OF THE ELECTRICITY SUPPLY CONTRACT

- (a) The terms and conditions as specified in the Electricity Supply Contract shall continue in full force and effect during the term of this Contract.
- (b) For the avoidance of doubt, in the event of any inconsistency between the terms and conditions of this Contract and the terms and conditions of the Electricity Supply Contract, the terms and conditions of this Contract shall prevail.

**NET ENERGY METERING (NEM) CONTRACT
FOR
NEM GOMEN**

NET METERING (NEM) CONTRACT FOR NEM GOMEN

DEFINITIONS

- (a) **ACT**
means the Electricity Supply Act 1990 (Act 447) and/or any regulations made thereunder and/or any amendment, revision, modification or enactment made thereto or thereof from time to time for the time being in force.
- (b) **BILLING CYCLE PERIOD**
means (i) the period beginning on the Commissioning Date and ending on the last day of the calendar year in which the Commissioning Date occurs; and (ii) each twelve (12) months' period thereafter during the term of this Contract, or such other period as may be approved by the Government of Malaysia from time to time.
- (c) **BILLING MONTH**
means the period between two (2) successive meter readings. The Net Meter is normally read at intervals of approximately thirty (30) days.
- (d) **CHANGE OF TENANCY**
means a change of the registered consumer who is responsible to make payment of electricity bill of an existing TNB's account.
- (e) **COMMISSIONING DATE**
means the date on which the Net Meter is commissioned as notified by TNB.
- (f) **COMPETENT PERSON**
means a person who holds a Certificate of Registration as an Electrical Contractor issued under the Electricity Regulations 1994.
- (g) **CONSUMER**
means any Government Agency who:
(i) is a registered consumer of TNB who has entered into the Electricity Supply Contract;
(ii) is or will be supplied with electricity whereby the Governmental Building is at the material time is connected or will be connected; and
(iii) is operating the Renewable Energy System on the rooftop of the Governmental Building.
- (h) **CONTRACT**
means the contract comprising of terms and conditions hereunder and NEM application form.
- (i) **ELECTRICITY SUPPLY CONTRACT**
means the existing electricity supply contract entered into between the Consumer and TNB for the supply of electricity in accordance with the Act.
- (j) **EXPORT ENERGY**
means the renewable energy generated and delivered by the Renewable Energy System to TNB's system, as measured in kWh by the Net Meter.

- (k) **GENERATED AMOUNT**
means an amount (in RM) equal to the Export Energy multiplied by the Tariff.
- (l) **GOVERNMENT AGENCY**
means a ministry, department or statutory body established by the government at all levels of administration whether at the federal, state and district levels including local authorities, under the commercial tariff.
- (m) **GOVERNMENTAL BUILDING**
means the building owned and used by the Consumer (other than for residential purpose) on which the Renewable Energy System is installed.
- (n) **IMPORT ENERGY**
means the electricity supplied by TNB and consumed by the Consumer, as measured in kWh by the Net Meter.
- (o) **INSTALLED CAPACITY**
means in respect of the Consumer falling under the tariff classification of Low Voltage or Medium Voltage, the installed capacity of the Renewable Energy System shall not exceed seventy-five per cent (75%) of the maximum demand of the Consumer's existing installations and capped at 1MW. Maximum demand shall be determined based on (A) in respect of a Consumer with less than one (1) year history of recorded maximum demand, the declared maximum demand, and (B) in respect a Consumer with at least one (1) year history of recorded maximum demand, the average of the recorded maximum demand for the immediately preceding one (1) year period.
- (p) **kW**
means kilowatt.
- (q) **kWh**
means kilowatt-hour.
- (r) **LOW VOLTAGE**
in the context of tariff classification means a supply voltage less than 1000 volts.
- (s) **MEDIUM VOLTAGE**
in the context of tariff classification means a supply voltage from 1,001 volts to 50,000 volts.
- (t) **METER INSTALLATION CHARGES**
means an upfront contribution amount payable by a Consumer requiring infrastructure for new supply and/or upgrading of existing infrastructure for additional supply requirement and for the purpose of this Contract, the installation and connection of Net Meter, as approved by the Suruhanjaya Tenaga or any relevant authority.
- (u) **MW**
means megawatt.

- (v) **NEM MONTHLY MINIMUM CHARGE (NMMC)**
means a monthly charge applicable to the Consumer in the event its monthly total charge for the difference between the Import Energy and the Export Energy is less than the stated amount stipulated in the prevailing Tariff as approved by the Government of Malaysia.
- (w) **NET METER**
means the metering equipment and devices supplied and installed by TNB for the measurement of the Import Energy and the Export Energy.
- (x) **RENEWABLE ENERGY METER**
means the renewable energy meter to be procured and installed at the Governmental Building for the purpose of capturing the gross renewable energy generated from the Renewable Energy System.
- (y) **RENEWABLE ENERGY SYSTEM**
means the renewable energy system located on the rooftop of the Governmental Building which fully complies with the Technical Guidelines and the guidelines as may be issued by the Suruhanjaya Tenaga, grid-connected inverter, storage devices (if any), the associated protection and control devices (including but not limited to isolator and relay), alternating current and direct current cables, switches and other related devices up to the Consumer's termination point.
- (z) **SUPPLIED AMOUNT**
means an amount (in RM) equal to the Import Energy multiplied by the Tariff.
- (aa) **SURUHANJAYA TENAGA**
means the Suruhanjaya Tenaga established under the Energy Commission Act 2001 and any successor thereof.
- (bb) **TARIFF**
means the prevailing tariff, as provided by the Act and approved by the Government of Malaysia.
- (cc) **TARIFF BOOK**
means TNB's tariff book as may be amended, revised, modified or supplemented from time to time.
- (dd) **TECHNICAL GUIDELINES**
means TNB's technical guidelines as may be amended, revised, modified or supplemented from time to time, which provide the minimum technical, operation and safety requirements in ensuring that the features of the Renewable Energy System and the Net Meter are compatible with TNB's requirements.
- (ee) **TNB**
means Tenaga Nasional Berhad (200866-W), a company incorporated in Malaysia under the Companies Act 1965 and having its registered address at Pejabat Setiausaha Syarikat, Tingkat 2, Ibu Pejabat Tenaga Nasional Berhad, No. 129, Jalan Bangsar, 59200 Kuala Lumpur and having branches in Peninsular Malaysia.

A. TERM OF CONTRACT

This Contract shall be effective on the Commissioning Date and shall remain in effect for a term of ten (10) years which expires on the last day of the month in which the tenth (10th) anniversary of the Commissioning Date occurs, unless otherwise terminated in accordance with the provisions of this Contract.

Upon the expiry of the term of this Contract, the Consumer agrees with TNB that the Consumer shall be registered by TNB as self-consumption and subject to the guidelines relating to self-consumption as issued by the Suruhanjaya Tenaga.

B. CONSUMER'S COVENANTS

1. CONSUMER DECLARATION

The Consumer shall abide at all times to the Consumer Declaration as stipulated in the NEM application form and the following terms:

- (a) To ensure that the Renewable Energy System complies with the Technical Guidelines, all prevailing statutory requirements and best practices on safety, reliability and power quality of electrical installation as stipulated in the Malaysian Distribution Code and any amendments made thereunder.
- (b) The Renewable Energy System shall incorporate an anti-islanding function to ensure that the Renewable Energy System automatically disconnect from TNB's system during power interruption to allow TNB's personnel to work safely on the TNB's system.
- (c) Any other obligations under the Act.

2. REPRESENTATIONS AND WARRANTIES OF THE CONSUMER

The Consumer represents and warrants to TNB that:

- (a) The Consumer is an entity duly organised and validly existing under the laws of Malaysia.
- (b) The Consumer has all requisite power and authority to execute, deliver and perform its obligations under this Contract.
- (c) The Consumer has full control and possession of the Governmental Building, including all necessary ownership rights, leases, tenancies, title and/or interest of the Governmental Building.
- (d) The Consumer shall comply with the provisions of all statutes, ordinances, by-laws, regulations and rules for the time being in force affecting the Governmental Building or any constructions, improvements, installations, additions or alterations thereon and forthwith to satisfy all requirements of the municipality or any other local authority with respect to the Governmental Building.
- (e) If the Consumer is a tenant of the Governmental Building, the Consumer shall have obtained the prior written consent of the owner of the Governmental Building for the installation and commissioning of the Net Meter.
- (f) The Consumer is not subject to any pending action or proceeding affecting the Consumer before any court, government entity or arbitrator that is likely to affect materially and adversely the financial condition or operations of the Consumer and the ability of the Consumer to perform its obligations hereunder, or that purports to affect the legality, validity or enforceability of

this Contract.

- (g) The Consumer shall remain a Consumer of record of TNB for its own electricity consumption in good standing at all times, and shall not cause the Renewable Energy System, the Renewable Energy Meter and the Net Meter to be disconnected or removed from the Governmental Building without the prior written consent of TNB.
- (h) The total capacity of the Renewable Energy System shall not exceed the Installed Capacity.
- (i) The specifications of the Renewable Energy System shall be as set in the NEM application form.
- (j) The Consumer shall have procured the installation of the necessary GPRS broadband signal at the Governmental Building which is required for the remote reading of the Net Meter.
- (k) The Consumer shall comply with the terms and conditions under this Contract and the provisions under the Act.
- (l) The Consumer shall not install and operate virtual net meter which enables the Consumer to allocate the net excess in kWh generated by the Renewable Energy System to other consumer within the vicinity of the Governmental Building.
- (m) The Consumer shall immediately notify TNB of any change in the Consumer's information as provided for the purpose of this Contract.
- (n) The Consumer undertakes to operate and maintain the Renewable Energy System in accordance with the Technical Guidelines and the guidelines as may be issued by the Suruhanjaya Tenaga.
- (o) The Consumer shall immediately notify the Sustainable Energy Development Authority of any change in the Consumer's tariff classification.
- (p) This Contract constitutes a legal, valid and binding obligation of the Consumer.

3. METER INSTALLATION CHARGE

To pay to TNB a Meter Installation Charge in full (if any) and such payment to be paid before any work of installation and connection of the Net Meter is commenced by TNB, as provided in the Act.

4. DISCONNECTION FEE

In the event the Renewable Energy System is disconnected from TNB's system and/or electricity supply is disconnected from the Governmental Building, then appropriate fees shall be charged for such disconnection.

5. ACCESS

The Consumer consents with TNB that the authorised employees, servants, agents and/or representatives of TNB shall be permitted to have access to the Governmental Building at reasonable time, manner and circumstances:

- (a) To carry out their duties which include but not limited to the construction, installation, inspection, testing and/or reading of the Net Meter, the Renewable Energy Meter and/or the Renewable Energy System or other relevant things relevant to the supply of electricity to the Governmental Building.
- (b) To disconnect the Renewable Energy System from TNB's system and/or the supply of electricity to the Governmental Building upon the occurrence of any of the circumstances as set out in Clause 22.

- (c) For entry pursuant to Clause 5(a), TNB shall make good any damage, if any, as a result of such entry.

6. COSTS AND EXPENSES FOR RENEWABLE ENERGY SYSTEM, NET METER AND RENEWABLE ENERGY METER

All costs and expenses relating to the procurement, installation, testing, energizing and commissioning of the Renewable Energy System, the Net Meter and the Renewable Energy Meter together with the replacement or any future modification or relocation of the Renewable Energy System, the Net Meter and the Renewable Energy Meter shall solely be borne by the Consumer.

7. NO INTERFERENCE OF ELECTRICITY SUPPLY TO OTHER CONSUMERS

- (a) To operate and maintain the Renewable Energy System and/or use electricity supply so as not to interfere with the supply of electricity to any other consumers or TNB's electrical installation.
- (b) In the occurrence of the circumstances in Clause 7(a), the Consumer shall make good any loss or damage to TNB and/or made payment for the amount in the reasonable opinion of TNB to be the costs making good for such loss or damage.

8. NO OBSTRUCTION TO TNB'S INSTALLATION

- (a) The Consumer shall not create any obstruction and/or undertake any activity in the vicinity of any TNB's electrical installation and/or place any equipment which may endanger life or properties and/or to make any electrical wiring and/or installation to the existing installation without any written permission from the Suruhanjaya Tenaga and/or TNB.
- (b)
 - (i) TNB has the right to take any reasonable actions to remove any obstruction created by the Consumer or representative under Consumer's supervision/control.
 - (ii) TNB shall not be liable to pay any compensation for any losses and/or damages to the Consumer due to the said removal.

9. RESPONSIBILITY TO MAKE GOOD ALL DAMAGES

The Consumer shall pay for all damages on TNB's installation within the Governmental Building due to negligence on the Consumer's part or any persons under the Consumer's control.

10. TERMINATION BY THE CONSUMER

- (a) To give TNB a notice in writing and shall be served by:
 - (i) hand delivery; or
 - (ii) way of prepaid registered post; or
 - (iii) any applicable means which shall be determined by TNB.
- (b) Termination of this Contract shall be effective three (3) working days after TNB's receipt of termination notice.
- (c) Notwithstanding to the above, in the event the actual disconnection cannot be performed by TNB due to inevitable causes, the Consumer shall be liable to pay all charges relating to the electricity consumed until the actual disconnection.

11. TO TAKE SUPPLY OF ELECTRICITY

To take supply of electricity at the Governmental Building according to the Tariff rates pursuant to the provision of the Act.

12. EXCEPTIONS TO ACCEPT THE EXPORT ENERGY

Notwithstanding any other provision in this Contract, TNB shall not be obligated to accept the Export Energy if any of the following circumstances occurs:

- (a) for such periods and under such circumstances as TNB thinks fit having regard to public safety and private safety;
- (b) any emergency condition occurs;
- (c) the Renewable Energy System delivers the Export Energy which does not conform to the electrical characteristics consistent with prudent utility practices;
- (d) TNB interrupts the acceptance of the Export Energy to conduct necessary maintenance of TNB's system or the Net Meter;
- (e) any constraint in TNB's system to which the Renewable Energy System relates;
- (f) any dishonest consumption of the electricity by the Consumer or any third person;
- (g) any of the force majeure event as set forth in Clause 24;
- (h) the disconnection of the Renewable Energy System from TNB's system due to the failure of the Consumer to pay the amount as stipulated under Clause 21; or
- (i) the Consumer is in non-compliance with its obligations under Clause 2.

13. UPKEEP AND MAINTENANCE OF TNB INSTALLATION

The Consumer agrees:

- (a) to take steps to ensure that no damage or tampering is caused to the said installation; and
- (b) to allow TNB to maintain any electrical installation within the Governmental Building at any time for safety purposes.

If there is any defect or abnormality on the installation, TNB shall have the right to make good the defects without being liable for any damages provided always it is not due to the negligence or willful acts of TNB, its employees or agents.

14. VACATED PREMISES

- (a) If the Consumer vacates the Governmental Building without giving any notice to TNB as provided under Clause 10, the Consumer shall be liable to pay all charges of electricity consumed and any charges payable relating to the electricity consumed until the installation is disconnected or upon the termination of this Contract, whichever is the later.
- (b) TNB shall have the right not to provide electricity supply to any other premises in which the account is registered under the Consumer's name until the Consumer has made the full payment of the outstanding balance.

15. NON-TRANSFERABLE AND NO SETTING OFF OF CREDIT AMOUNT

- (a) The Consumer shall not be entitled to transfer any credit amount as described in Clause 21(c) below to any other accounts of the Consumer or any third party account. For the avoidance of doubt, any remaining credit amount which may be subsisting at the end of each Billing Cycle Period or

upon the termination of this Contract, as the case may be, shall be adjusted to zero without any compensation to the Consumer.

- (b) The Consumer shall not be entitled to set off any credit amount as described in Clause 21(c) below against any outstanding sums due and payable to TNB under the Electricity Supply Contract.

C. TNB'S COVENANTS

16. LOCATION OF TNB'S INSTALLATIONS

- (a) If any removal made to any TNB's installation and equipment which is likely to cause danger as provided under the Act, TNB shall have the right to disconnect electricity supply without notice.
- (b) If any relocation made to any TNB's installation and equipment without consent, TNB shall have the right to disconnect the electricity supply without notice and relocate the said installation and equipment with costs borne by the Consumer.

17. INSPECTION BY TNB

- (a) TNB may need to inspect and test all installations before connection of the Renewable Energy System or electricity supply. However, it is the responsibility of the Competent Person appointed by the Consumer to ensure that the installations are safe.
- (b) The Consumer shall inform TNB of any proposed extensions or alterations to the installations so that TNB may make inspection and test of the extension or alteration if TNB so desires.
- (c) TNB does not accept any responsibility for any loss or damage caused by or occurs during or after test due to any defect in the installation and any test carried out by TNB is for TNB's purposes only and does not imply any warranty that the installation is suitable for the Consumer's purposes or that it fully complies with the Technical Guidelines and the Act or any subsequent amendments made thereunder.

18. TEMPORARY DISCONNECTION

TNB may temporarily disconnect the supply of electricity to the Governmental Building for any purposes in connection with TNB's efficient electricity supply system. TNB shall not be liable to provide any alternative supply to the Consumer after the disconnection.

19. USAGE OF INSTALLATION FOR OTHER CONSUMER

TNB may use its part of the installation to supply electricity to other consumers in the area.

D. MUTUAL COVENANTS

20. EQUIPMENTS AND INSTALLATIONS

Any installation comprising mains and service lines and other ancillary equipment up to and including the Net Meter will be the property of TNB.

21. BILLING AND PAYMENT

- (a) TNB shall read the Net Meter on a monthly basis and shall measure the Import Energy and the Export Energy to determine the Supplied Amount and the Generated Amount respectively. The calculation of the Supplied Amount and the Generated Amount shall be based on the guidelines as may be issued by the Suruhanjaya Tenaga.
- (b) If, during any relevant Billing Month, the Import Energy exceeds the Export Energy, then the Consumer shall be billed for an amount (in RM) equal to the difference between (i) the sum of Supplied Amount and the appropriate charges and taxes and (ii) the Generated Amount and the appropriate taxes. The bills rendered by TNB to the Consumer shall be paid by the Consumer within the stipulated period.
- (c) If, during any relevant Billing Month, the Export Energy exceeds the Import Energy, then the Consumer shall be credited for an amount (in kWh) equal to such difference in the following Billing Month. Notwithstanding the above, the Consumer shall pay any appropriate taxes and charges (if any).
- (d) At the end of each Billing Cycle Period or upon the termination of this Contract, as the case may be:
 - (i) any remaining amount as described in Clause 21(b) above shall be billed and paid by the Consumer in accordance with Clause 21(b); and
 - (ii) any credit amount as described in Clause 21(c) above which may be subsisting at the end of such Billing Cycle Period or upon the termination of this Contract shall be adjusted to zero without any compensation to the Consumer.

For the avoidance of doubt, if this Contract is terminated prior to the end of a Billing Cycle Period, any credit amount as described in Clause 21(c) above which may be subsisting shall be adjusted to zero without any compensation to the Consumer.

- (e) In addition to the total payable amount as stated in any monthly bill for any Billing Month as described under Clause 21(b) and Clause 21(c), the Consumer may be imposed with a grid fixed charge and the appropriate taxes as provided in this Contract, if any.
- (f) Notwithstanding anything hereinbefore mentioned, TNB shall have the right to impose the NEM Monthly Minimum Charge in the event the monthly total charge for the difference between the Import Energy and the Export Energy is less than the stipulated amount in the Tariff Book.
- (g) TNB shall have the right to impose or levy a surcharge at the rate as prescribed under the Act on the outstanding amount, calculated until the date of full payment.
- (h) The Consumer shall be liable for electricity bills issued by TNB including any unpaid amount insofar as the account is registered under the Consumer's name regardless of any consumption of electricity by any third party.
- (i) The Consumer shall be responsible to repay the amount in the bills rendered by TNB including any other relevant charges for any invalid payment made by the Consumer such as false credit card, bounced cheque and any other invalid payment.
- (j) In the event the Consumer fails to make payments as required under this Clause 21, TNB shall have the right to disconnect the Renewable Energy System from TNB's system and/or the supply of electricity to the

Governmental Building or any other premises which is registered under the Consumer's name.

- (k) The Consumer shall be liable for any arrears of electricity bill and/or loss suffered by TNB by reason of dishonest consumption of electricity supply in all circumstances in accordance with the provisions of the Act.
- (l) TNB shall have the right to make adjustment and update of Consumer's account whenever necessary.
- (m) TNB shall be entitled to set off any amount due to it under this Contract against any sums due and payable to the Consumer under the terms of this Contract.

22. DISCONNECTION OF SUPPLY

- (a) Subject to the Act, TNB shall have the right to disconnect the Renewable Energy System from TNB's system and/or the supply of electricity to the Governmental Building without giving prior notice in any situations mentioned below:
 - (i) any default by the Consumer under Clause 23 and such default are not remedied within the stipulated period if any;
 - (ii) by Court Order/Judgment;
 - (iii) if in the opinion of TNB that the continuation of the delivery of renewable energy by the Renewable Energy System to TNB's system or the supply of electricity to the Governmental Building will jeopardize the safety, reliability or security of TNB's system or presents an imminent physical threat or endanger the safety, life or health of any person or property;
 - (iv) upon the receipt of the termination notice indicating the intention to terminate this Contract by either TNB or the Consumer;
 - (v) any removal made to any TNB's installation and equipment as described in Clause 16(a);
 - (vi) the occurrence of the circumstances as described in Clause 12(d) or Clause 12(e); or
 - (vii) any right to disconnect the Renewable Energy System from TNB's system and/or the supply of electricity to the Governmental Building without notice as provided under the Act.
- (b) For the avoidance of doubt, the Consumer hereby irrevocably and unconditionally agrees and acknowledges that:
 - (i) TNB shall be excused from all its obligations under this Contract in the event TNB exercises its rights to disconnect the Renewable Energy System from TNB's system and/or the supply of electricity to the Governmental Building in any situations as set out in this Clause 22; and
 - (ii) TNB shall not be responsible for any loss or damage that may arise as a result of the disconnection of the Renewable Energy System from TNB's system and/or the supply of electricity to the Governmental Building.

23. EVENT OF DEFAULT

The occurrence of any of the following shall constitute an event of default under this Contract and it is not limited to:

- (a) Act or default of the Consumer affecting the efficiency and/or safety of TNB's installation.

- (b) The Consumer has failed to comply and/or breach with any provision of this Contract and/or the Act and/or commit any offence under the Act.
- (c) The Consumer acknowledges in writing its inability to pay its debt as such debts become due.
- (d) Failure to pay the amount as stipulated under Clause 21 above.
- (e) Any warranty, representation or covenant made by the Consumer in this Contract is false or inaccurate in any material respect.
- (f) The occurrence of a Change of Tenancy.
- (g) Consumption of electricity in any dishonest manner.
- (h) The Consumer fails to comply with any of the provisions stipulated under Clause 1 of this Contract.
- (i) The Electricity Supply Contract is terminated for any reason whatsoever.
- (j) In the event the Consumer vacates the Governmental Building pursuant to Clause 14(a).
- (k) Any change of the Consumer in the tariff classification without TNB's written approval.

24. FORCE MAJEURE

Neither party shall be liable to the other party for any breach of terms and conditions of this Contract due to any of this event which shall include but not limited to national emergency war, hostilities, riot, civil commotion, earthquake, flood, disposition or by compliance with any order of government, local or any other authorities.

25. INDEMNITY AND NO LIABILITY CLAIM

- (a) The Consumer agrees to indemnify and keep indemnified (indemnifying) TNB from and against all and/or any claims, actions, compensations, suits, proceedings, demands and all legal costs incurred thereby, brought against TNB, its servants or agents by a third party to which TNB shall or may be or become liable in respect of or arising from the performance of this Contract provided always it is not due to the negligence or willful acts of TNB, its employees or agents.
- (b) The Consumer shall at all times be fully liable to TNB and remain responsible for all damages flowing from any breach or default of any term or obligation in this Contract regardless of whether the Renewable Energy System and the Renewable Energy Meter are installed and owned by a third party or otherwise.
- (c) The Consumer hereby agrees that neither TNB nor its employees, servants, agents, representatives shall be liable and/or make good the Consumer in respect of any damage, injury or loss to any of the Consumer's property and/or life arising from any fault of the TNB's system or the Consumer's installation at the Governmental Building unless such damage, injury or loss have been proven as a result of any willful act, negligence, omission and/or failure to comply with any safety measures as provided under any written law.
- (d) The Consumer hereby agrees further that TNB shall not be liable for any cost incurred, loss and/or damage of industrial goods, product, property or life of the Consumer as a result of any unavoidable accident, voltage fluctuation, interruption, reduction and/or cessation of the electricity supply, fire or accident that may occur in consequence of the supply of electricity or the

use or misuse which is not due to the negligence or willful act of TNB and/or its employees.

26. NOTICES

Unless and otherwise provided under the Act and any Clause stated under this Contract, any notice, demand or other communication which is required or allowed to be given or made under this Contract shall be in writing and shall be served by hand delivery or by way of prepaid registered post or ordinary post or any electronic means as mutually agreed by both parties to the address stated in this Contract. Proof of posting or service of any notice, demand or communication shall be deemed to be duly served:

- (a) if service is delivered by hand, at the time of such delivery and duly acknowledged;
- (b) if service is by way of post, on the third (3rd) working day after posting thereof; or
- (c) if service is delivered by electronic means, at the time of such delivery report.

Provided that the above Clause 26 shall not be applied to the termination of this Contract.

27. REMOVAL OF TNB INSTALLATION

If the Consumer or the proprietor of the Governmental Building requests TNB to remove or relocate the supply line, pole, sub-station, pylon or any other TNB's installation or equipment within or outside the Governmental Building, subject to consent by TNB, all costs of executing the removal or relocation shall be fully borne by the Consumer or the proprietor as the case may be.

28. SERVICES OF LEGAL PROCESS

The service of any legal process shall be by way of prepaid registered post sent to the address as stated in this Contract. Proof of posting shall be regarded as proof of acceptance and the said service shall be deemed to have been duly served and duly received upon the expiry of five (5) days from the date of posting.

29. TERMINATION OF CONTRACT BY TNB

- (a) TNB may terminate this Contract at any time upon giving not less than fourteen (14) working days' notice in writing of its intention to do so.
- (b) TNB may terminate this Contract under Clause 22(a) by giving fourteen (14) working days' notice from the date of expiry of the remedy period, except for the situations in Clause 22(a)(ii) and Clause 22(a)(iv).
- (c) If the Consumer renders to TNB a temporary notice of disconnection of the Renewable Energy System from TNB's system and/or the supply of electricity to the Governmental Building thereby it shall be deemed as a notice of termination of the Contract and subject to the issuance of notice under Clause 29(a).
- (d) If TNB discovers that the information given is false and/or is disputed with the existence of prima facie proof relating to the delivery of renewable energy by the Renewable Energy System and the supply of electricity to the Governmental Building and proven by any applicable laws or court order, TNB shall have the right to terminate this Contract upon giving a written notice of not less than twenty-four (24) hours.

- (e) If TNB for any reasons pursuant to any laws or under any direction of the Suruhanjaya Tenaga and/or relevant authority has been given the right to terminate this Contract.

30. CONSEQUENCES OF TERMINATION

On such effective date of termination under Clause 10 or Clause 29,

- (a) TNB shall be discharged from any obligations and liabilities under this Contract including any claim for damages without prejudice to TNB's rights to make such claim due to the disconnection of the Renewable Energy System from TNB's system and/or the supply of electricity to the Governmental Building and the termination of this Contract;
- (b) the terms and conditions as specified in the Electricity Supply Contract shall then be applicable; and
- (c) this Clause 30 shall survive the termination of this Contract.

31. TRANSFER OF OUTSTANDING AMOUNT AND BALANCE OF DEPOSIT

- (a) TNB shall have the right to transfer any outstanding amount of electricity bills from any vacated account of the Consumer to any active account registered under the Consumer's name.
- (b) If there is a balance of deposit from the Consumer's vacated account, TNB shall have the right to use the balance of the deposit to adjust for any outstanding amount from whichever active account registered under the Consumer's name.

32. ENVIRONMENT ATTRIBUTE

The value of any credits or financial benefits which are available or may become available for reductions of "green house gas" emissions earned from the generation of renewable energy by the Renewable Energy System shall be solely for the benefit of the Consumer.

E. MISCELLANEOUS

33. AMENDMENT, MODIFICATION OR REPLACEMENT

TNB reserves the right to amend, modify, revise or replace the terms and conditions stipulated under this Contract from time to time. TNB may give notice of amendment to the Consumer in such a manner as TNB reasonably deems appropriate.

34. CHANGE IN NEM SCHEME AND/OR THE ACT

In the event of any change in the NEM scheme and/or the Act including but not limited to the application of the Technical Guidelines or the discontinuation of the NEM scheme as decided by the Government of Malaysia, TNB may by written notice to the Consumer unilaterally amend the terms and conditions of this Contract in any manner that it deems fit in order to ensure the compliance of the Government of Malaysia's decision, the Act and the Technical Guidelines.

35. ASSIGNMENT

The Consumer shall not assign any of the rights or obligations arising under this Contract to any third party without the prior consent in writing of TNB. TNB shall be entitled to assign or transfer its interest, rights and obligations in whole or in part

under this Contract without the Consumer's prior written consent and the Consumer hereby agrees to execute such agreement and do such things as may be required by TNB to give effect to such assignment and/or transfer.

36. CONFIDENTIALITY

- (a) Except as it is or becomes a part of the public domain or as provided hereunder, all information provided by either party under this Contract shall be confidential at all times unless specified otherwise in writing.
- (b) The Consumer agrees that TNB may disclose all information provided by the Consumer under this Contract (including but not limited to any data or information from the reading of the meters), without limitation to the relevant departments and subsidiaries of TNB, including TNB's agents, advisors and outsource service providers, inside or outside of Malaysia, as well as the Suruhanjaya Tenaga, any other government entity and court or if required by any laws and regulations made thereunder.

37. GOVERNING LAW

This Contract shall be governed by and construed in accordance with the Act and any regulations made thereunder including any amendment thereto as well as any other relevant written laws.

38. INSTALLATION OF EQUIPMENT TO GENERATE RENEWABLE ENERGY

The Consumer shall inform TNB on any equipment installed at the Governmental Building for the purpose of generating renewable energy.

39. PERSONAL DATA PROTECTION

- (a) Both parties agree to comply and have adequate measures in place to ensure compliance at all times with the provisions and obligations contained in all applicable laws and regulations in Malaysia, including but not limited to the Personal Data Protection Act 2010, its subsidiary legislation and associated code of practice as amended from time to time in order to collect, use, process, record, hold, store, share and/or disclose any or all information related to the performance and obligations under this Contract.
- (b) The Consumer shall not cause or permit the Personal Data to be transferred outside Malaysia without the prior written consent of TNB or the Consumer shall ensure that the cross-border country must have the data protection legislation at least equivalent to the level of protection afforded by the Personal Data Protection Act 2010 (if any).
- (c) The Consumer shall implement adequate technical and organisational security measures to protect the Personal Data from any loss, misuse, modification, unauthorised or accidental access or disclosure, alteration or destruction.
- (d) The Consumer shall have the obligation to securely dispose of all Personal Data whether in written, electronic or other form or media given by TNB, and certify in writing to TNB that such Personal Data has been disposed of securely, upon expiry or termination of this Contract.
- (e) Upon default, the defaulting party shall be liable for and shall indemnify (and keep indemnified) against each and every action, proceeding, liability, cost, claim, loss, expense (including reasonable legal fees and disbursements on a solicitor client basis) and demands incurred by the aggrieved party which arise directly or in connection with the defaulting party's processing of

Personal Data pursuant to this Contract, including without limitation those arising out of any third party demand, claim or action, or any breach of contract, negligence, fraud, willful misconduct, breach of statutory duty or non-compliance with any part of the data protection legislation by the defaulting party or its employees, servants, agents or representatives.

- (f) The Consumer has read and fully understands TNB's Personal Data Protection Policy which is available at <https://www.tnb.com.my/terms-policy/personal-data-protection-policy-pdpa/>.
- (g) The Consumer shall provide assistance as reasonably requested by TNB in relation to any complaint or request made, including by:
 - (i) providing any information reasonably requested by TNB; and
 - (ii) providing TNB with full details of the complaint or request (if any).
- (h) For the purpose of this Clause 38, the term Personal Data shall have the meaning given to it in TNB's Personal Data Protection Policy.

40. SEVERABILITY

If any one or more of the provisions or part thereof contained in this Contract should be or become invalid or unenforceable due to whatsoever reasons this shall not in any way affect or impair the validity or enforceability of the remaining provision hereof.

41. STAMP DUTY

The stamp duty in respect of this Contract shall be borne and fully paid by the Consumer.

42. SUCCESSORS-IN-TITLE

This Contract shall be binding upon the successors-in-title and permitted assigns of the respective parties hereto.

43. TAXES

The Consumer shall be responsible for all present and future taxes, duties, levies and other similar charges including any related interest and penalties, however designated, arising out of or in connection with the supply of any kind imposed by law.

44. TIME PERIOD

Time wherever mentioned shall be the essence of this Contract.

45. WAIVER

Knowledge or acquiescence by TNB of or in breach of any of the conditions or covenants herein contained shall not operate as or be deemed to be waiver of such conditions or covenants or any of them and notwithstanding such acknowledge or acquiescence, TNB shall be entitled to exercise its rights under this Contract.

46. APPLICABILITY OF THE ELECTRICITY SUPPLY CONTRACT

- (a) The terms and conditions as specified in the Electricity Supply Contract shall continue in full force and effect during the term of this Contract.
- (b) For the avoidance of doubt, in the event of any inconsistency between the terms and conditions of this Contract and the terms and conditions of the Electricity Supply Contract, the terms and conditions of this Contract shall prevail.

NET ENERGY METERING 3.0 (NEM 3.0) NEM RAKYAT & NEM GOMEN APPLICATION FORM

PART 1: CONSUMER INFORMATION

Name of Consumer : _____

TNB Account Number : _____

Installation Address : _____

Contact Number : H/P _____ Home _____

Email : _____

NEM Application Number : _____

NEM Type : NEM Rakyat NEM GoMEn

Installation of Self Consumption (SelCo) : Yes No If Yes, SelCo Capacity: _____ (kW)

PART 2: NEM SOLAR PV SYSTEM INFORMATION

Total Generation Capacity : _____ kW

Commissioning Date of NEM Solar PV System : _____ (dd/mm/yyyy)

Inverter Manufacturer : _____

Inverter rating : _____ kW

Number of Phases : Single Phase Three Phase

PART 3: COMPETENT PERSON/SERVICE PROVIDER DECLARATION

I declare that:

- I am representing the owner of the premise and the information furnished above is true to my knowledge and belief.
- I confirm that the solar PV system design comply to the standards (IEEE 1547 / IEC 61727 / MS 1837) and NEM Guideline including NEM Technical Guideline.
- I also verify that the site condition is fit for installation of the solar PV system as per applicable regulations.
- I hereby acknowledge that all information given are true and the relevant Authority shall have the right to take any action if the above information are false.
- I attached the Testing and Commissioning (T&C) form as evidence that all required T&C has been done.
- I enclose a valid G & H forms to which the NEM solar PV installation is attached or wired for the electricity supply.

Competent Person/Professional Engineer/
Service Provider Signature

Name:
Designation:
IC No:

PART 4: NEM CONSUMER'S DECLARATION

I hereby declare that the information provided in the Form A (SEDA's NEM application form) and this TNB's NEM application form is true to the best of my knowledge and belief. In case any of the above is found to be false, I am aware that TNB has the right to reject/terminate/cancel my application and forfeit my application fees. I further agree to comply with the specifications, terms and conditions stipulated in the applicable guidelines and related regulations by TNB and EC, as amended from time to time. Upon the expiry of the term of this NEM Contract, I agree that my solar PV installation shall be registered by TNB as self-consumption. I also confirm that I have read and understood the NEM Contract for the connection of NEM solar PV installation and agree to abide by them.

NEM Consumer's Signature

Name:

IC No:

PART 5: FOR OFFICE USE ONLY

TNB Executive's signature

Staff Name:

Staff No. :

Designation:

Chop:

ATTACHMENT 1

**REGISTRATION FORM TO ENERGY COMMISSION
(for installation that is exempted from licensing)**

PART 1: CONSUMER INFORMATION

Applicant Name: _____ IC/ROC Number: _____
Electricity Bill account number: _____
Electricity Supply Company: _____
Email address: _____ Phone Number: _____
Mailing Address: _____

I hereby authorize the Competent Person as described in PART 4 to act on my behalf to manage my registration

Signature: _____ Date: _____

PART 2: COMPETENT PERSON (ELECTRICAL CONTRACTOR) DETAILS

Name: _____ IC/ Certification No.: _____
Company Name: _____ Company ROC No: _____
Phone Number: _____ E-mail address: _____
Mailing Address: _____

PART 3: SOLAR PHOTOVOLTAIC (PV) INSTALLATION INFORMATION

Installation Address: _____

Installation Site Ownership: Fully Owned Owned (charged to bank) Leased

If not fully owned, please provide the owner's name: _____

Voltage at point of interconnection: Low Voltage (230V/400V) Medium Voltage (11kV/33kV)
@Utility meter

Reasons for installing solar PV system Reduce electricity bill Peak Shaving
 Reduce Green House effect Other reasons: _____

Installation Type (Rooftop) Commercial Domestic
 Agriculture Industrial
 Water body Others: _____

PART 4: TECHNICAL INFORMATION

- a) Maximum demand of existing installation _____ kW
- b) Installed Solar PV Capacity _____ in kW_p; _____ in kW_{ac}
- c) Expected generation per month _____ kWh
- d) Date of Commissioning of solar system: _____ (dd/mm/yyyy)
- e) Installation of Battery Energy Storage System: Yes No If yes, Battery capacity _____ kW
 Battery Manufacturer: _____
- f) Daytime Peak Demand (11am to 3pm) _____ kW (Friday to Monday)
- g) Daytime Lowest Demand _____ kW
- Note: For Domestic, solar PV system installed capacity shall not be more than 4kWp (single phase) or 12kWp (three phase).
 For Non-Domestic, solar PV system installed capacity shall not be more than 75% or 100% of SelCo+ Consumer MD.*
- h) PV Module : i) Type: Monocrystalline Polycrystalline Thin Film Others: _____
 : ii) Manufacturer _____
 : iii) Module capacity _____
- i) PV Inverter i) Number of inverter installed _____
 ii) Inverter capacity _____
 iii) Type: Single Phase Three Phase
 iv) Manufacturer _____
 v) Power Factor: _____ lagging _____ leading unity

PART 5: DECLARATION

By signing this form, I declare that:

- I am representing the applicant of the premise and the information furnished above is true to my knowledge and belief.
- I hereby acknowledge that all information given are true and the relevant Authority shall have the right to take any action if the above information is false.
- I confirm that the solar PV system design comply to the standards (IEEE 1547, IEC 61727, MS 1837, Guidelines on Photovoltaic Installation for Self-Consumption) and the inverter (s) used are as per approved lists.
- I also verify that the site condition is fit for installation of the solar PV system as per applicable regulations.
- I further agree to comply with the specifications, terms and conditions stipulated in the applicable guidelines and related regulations, as amended from time to time.

Signature :

Competent Person stamp:

Name: _____

Date: _____



Suruhanjaya Tenaga
Energy Commission

**No. 12, Jalan Tun Hussein
Precinct 2**

62100 Putrajaya

Tel : +603 8870 8500

Fax : +603 8888 8637

Web : www.st.gov.my